



XGPON OLT Product Operation Manual

Version: V1.1

Release Date : 20220829

Content

Chapter 1 Access OLT	1
1.1 CLI	1
1.1.1 Command Syntax	2
1.1.2 Help of Command Line	3
1.1.3 Display history Command of Command Line	4
1.2 Manage Users	4
1.2.1 System Default User	5
1.2.2 Add User	5
1.2.3 Change Password	6
1.2.4 Modify User's Privilege Level	7
1.2.5 Delete User	7
1.2.6 Display Users	8
1.2.7 Display Users	8
1.2.8 Kick off Online Telnet Users	8
1.3 Remote Authentication Configure	9
1.3.1 Enable RADIUS/TACACS+	9
1.3.2 Display Authentication Method	9
1.3.3 TACACS+ Remote Server Configuration	9
1.3.4 Display TACACS+ Information	10
Chapter 2 System Management	11
2.1 System Maintenance	11
2.1.1 Display System Status Information	11
2.1.2 Configure the System Clock	11
2.1.3 Configure System Host Name	12

2.1.4 Trace Route Command	12
2.1.5 Port Loopback Test Command	13
2.1.6 Line Detection VCT Command	14
2.1.7 Management IP Address Configuration	15
2.1.8 Telnet User Limit for Login Privileged User View	16
2.1.9 CPU-CAR Command	17
2.2 Configuration Management	17
2.2.1 Save Configurations	17
2.2.2 Erase Configurations	18
2.2.3 Execute save Configuration	18
2.2.4 Show save Configurations	18
2.2.5 Show Running Configurations	19
2.3 Load Files and Upgrade Programs Online	19
2.3.1 Upload and Download Files by TFTP	19
2.3.2 Upload and Download Files by FTP	20
2.3.3 Download Files by Xmodem	22
2.4 Reboot OLT	22
Chapter 3 Port Configuration	24
3.1 Ethernet Port Configuration Overview	24
3.2 Configure Ethernet Port	24
3.2.1 Enter Interface Configuration Mode	24
3.2.2 Enter Interface Range Mode	24
3.2.3 Basic Port Configuration	25
3.2.4 Link Type of Ethernet Ports	26
3.2.5 Configure Default VLAN	27
3.2.6 Add Port to a Vlan	27
3.2.7 Dsisplay Port Information	28
3.2.8 Display and Clear Port Statistics	29
Chapter 4 Port Mirroring	30

4.1 Port Mirroring Overview	30
4.2 Configure Port Mirroring	30
4.2.1 Configure Port Mirroring	30
4.2.2 Configure the Mirror Destination Port	31
4.2.3 Configure the Mirror Source Port	31
4.2.4 Display Port Mirroring	32
Chapter 5 Link Aggregation	33
5.1 Link Aggregation Overview	33
5.1.1 Introduction to LACP	34
5.1.2 Operation Key (O-Key)	34
5.1.3 Static Aggregation Group	35
5.1.4 Dynamic LACP Aggregation Group	36
5.2 Redundancy of Interconnected Device	39
5.3 Load-balancing Policy	39
5.4 Configure Link Aggregation	39
5.4.1 Link Aggregation Configuration List	39
5.4.2 Configure a Static Aggregation Group	40
5.4.3 Configure Dynamic LACP	41
5.4.4 Display and Maintain LACP	42
Chapter 6 Port Isolation	44
6.1 Port Isolation Overview	44
6.2 Configure Port Isolation	44
6.2.1 Add/remove Isolated Ports	44
6.2.2 Display Port Isolation Configuration	45
Chapter 7 Storm-Control	46
7.1 Storm-Control Overview	46
7.2 Configure Storm-Control	46
7.2.1 Configure Storm-Control	46
7.2.2 Storm-Control Monitor and Maintenance	47

Chapter 8 VLAN	48
8.1 VLAN Overview	48
8.1.1 VLAN Principles	49
8.2 Configure 802.1Q VLAN	51
8.2.1 802.1Q VLAN Configuration List	51
8.2.2 Create and Modify VLAN	51
8.2.3 Delete Port Members from a VLAN	52
8.2.4 Delete VLAN	53
8.2.1 Configure Interface Default VLAN ID	53
8.2.2 Configure Interface VLAN Mode	54
8.2.3 VLAN Attributes Based on Hybrid Interface	55
8.2.4 VLAN Attributes Based on Trunk Interface	56
8.2.5 Configure Port Priority	57
8.2.6 Configure Ingress Filtering	57
8.2.7 Configure Types of Interface Acceptable-frame	58
8.2.8 Display VLANconfiguration	59
8.3 Configure MAC-Based VLAN	59
8.3.1 MAC-Based VLAN Overview	59
8.3.2 ConfigureMAC-Based VLAN	60
8.4 Configure Protocol-Based VLAN	60
8.4.1 Protocol-Based VLAN Overview	60
8.4.2 ConfigureProtocol-Based VLAN	61
8.5 Configure IP-subnet VLAN	62
8.5.1 IP-subnet VLAN Overview	62
8.5.2 ConfigureIP-subnet VLAN	62
Chapter 9 QinQ	64
9.1 QinQ Overview	64
9.1.1 Understanding QinQ	64
9.1.2 Implementations of QinQ	65

9.1.3 Modification of TPID Value of QinQ Frames	66
9.2 Configure QinQ	67
9.2.1 QinQ Configuration Task List	68
9.2.1 Configure BASIC QinQ	68
9.2.2 Configure Flexible QinQ	68
9.2.3 Display QinQ configuration	69
Chapter 10 MAC Address Table	70
10.1 MAC Address Table Overview	70
10.2 Configure MAC Address Table	70
10.2.1 MAC Address Table Configuration Task List	71
10.2.2 Configure the Aging Time	71
10.2.3 Add MAC Address Table by Manual	71
10.2.4 Display MAC Address Table	72
10.2.5 Enable/Disable MAC Learning	73
10.2.6 Quantity Limitation on MAC Address Learning Table	74
Chapter 11 STP	75
11.1 STP Overview	75
11.1.1 Protocol Packets of Spanning-Tree	75
11.1.2 Basic Concepts in Spanning-Tree	75
11.1.3 Spanning-Tree Interface States	77
11.2 How Spanning-Tree Works	79
11.3 Implement RSTP on Ethernet GPON	83
11.4 Configure RSTP	84
11.4.1 RSTP Configuration Task List	84
11.4.2 Enable RSTP and Configure the Working Mode	85
11.4.3 Configure STP Bridge Priority	85
11.4.4 Configure Time Parameter	86
11.4.5 Configure STP Path Cost	87
11.4.6 Configure STP Port Priority	87

11.4.7 Configure STP Mcheck	88
11.4.8 Configure STP Point-to-Point Mode	88
11.4.9 Configure STP Portfast	89
11.4.10 Configure STP Transit Limit	89
11.4.11 RSTP Monitor and Maintenance	89
Chapter 12 MSTP	91
12.1 MSTP Overview	91
12.2 Configure MSTP	91
12.2.1 Enable MSTP and Configure the Working Mode	91
12.2.2 Configure MSTP Timer Parameter Values	92
12.2.3 Configure MSTP Identifier	93
12.2.4 Configure MSTP Bridge Priority	93
12.2.5 ConfiConfigure Root Port Protection	94
12.2.6 Configure Digest Snooping Port	94
12.2.7 Configure Port mCheck Function	95
12.2.8 Configure MSTP Instance Is Enabled	96
12.2.9 Display and Maintain MSTP	96
Chapter 13 Remote-loop-detect	97
13.1 Remote-loop-detect Overview	97
13.2 Configure Remote-loop-detect	97
13.2.1 Enable Remote-loop-detect	97
13.2.2 Configure the Processing Policy	98
13.2.3 Configure the Interval Timer	98
13.2.4 Configure the Recovery Timer	99
13.2.5 Display Remote-loop-detect Configuration	99
Chapter 14 ACL	100
14.1 ACL Overview	100
14.1.1 ACL Overview	100
14.2 ACL Configuration	101

14.2.1 ACL Configuration List	101
14.2.2 Configure Match Order	101
14.2.3 Configure Time Range	103
14.2.4 Configure Basic ACL	105
14.2.5 Configure Extended ACL	107
14.2.1 Configure Layer 2 ACL	110
14.2.2 Activate ACL	112
14.2.3 Display and Debugging ACL	113
Chapter 15 QOS	115
15.1 QOS Overview	115
15.1.1 Traffic	116
15.1.2 Traffic Classification	116
15.1.3 Priority	116
15.1.4 Access Control List	119
15.1.5 Packet Filtration	120
15.1.6 Flow Monitor	120
15.1.7 Interface Speed Limitation	120
15.1.8 Redirection	121
15.1.9 Priority Mark	121
15.1.10 Choose Interface Outputting Queue for Packet	121
15.1.11 Queue Scheduler	121
15.1.12 Cos-map Relationship of Hardware Priority Queue and Priority of IEEE802.1p Protocol	123
15.1.13 Flow Mirror	123
15.1.14 Statistics Based on Flow	123
15.1.15 Copy Packet to CPU	123
15.2 Configure QOS	124
15.2.1 QoS Configuration List	124
15.2.2 Configure Flow Monitor	125

15.2.3 Configure Two Rate Three Color Marker	125
15.2.4 Configure Interface Line Rate	126
15.2.5 Configure Packet Redirection	126
15.2.6 Configure Traffic Copy to CPU	126
15.2.7 Configure Traffic Priority	127
15.2.8 Configure Queue-Scheduler	127
15.2.9 Configure Cos-map Relationship of Hardware Priority Queue and Priority of IEEE802.1p Protocol	128
15.2.10 Configure Mapping Relationship between DSCP and 8 Priority in IEEE 802.1p	129
15.2.11 Configure Flow Statistic	131
15.2.12 Configure Flow Mirror	131
15.2.13 Display and Maintain QoS	132
Chapter 16 SSH	134
16.1 SSH Overview	134
16.2 Configure SSH Server	134
16.3 Log in GPON from SSH Client	135
Chapter 17 SNMP	136
17.1 SNMP Overview	136
17.2 Configure SNMP-Agent	137
17.2.1 SNMP-Agent Configuration List	137
17.2.2 Configure the Basic Parameters	137
17.2.3 Configure the Community Name	139
17.2.4 Configure the Views	139
17.2.5 Configure the Group	140
17.2.6 Configure the User	141
17.2.7 Display SNMP-Agent Configuration	141
Chapter 18 Info-center	143
18.1 Info-center Overview	143

18.2 Configure Info-center	143
18.2.1 Info-center Configuration List	143
18.2.2 Enabling/Disabling the Info-center for the Equipment	144
18.2.3 Configure the Function of Display the Sequence Number in Info-center Outputs	145
18.2.4 Configure the Time Stamp Type in Info-center Outputs	146
18.2.5 Configure the Function of Outputting Info-center Information to Terminals	146
18.2.6 Configure the Function of Outputting Info-center Information to the History Buffer	148
18.2.7 Configure the Function of Outputting Info-center Information to the Flash Storage	149
18.2.8 Configure the Function of Outputting Info-center Information to the Log Host	151
18.2.9 Configure the Function of Outputting Info-center Information to the SNMP Agent	153
18.2.10 Configure the Module Debugging Function	154
Chapter 19 L3 Base Function	156
19.1 L3 Base Function Overview	156
19.2 Configure L3 Base Function	156
19.2.1 L3 Base Function Configuration List	156
19.2.2 Planning VLANs and Creating L3 Interfaces	157
19.2.3 Configure the Forwarding Mode	157
19.2.4 Creating VLAN Interfaces for Common VLANs	158
19.2.5 Creating SuperVLAN Interfaces and Adding VLANs to the SuperVLAN	159
19.2.6 Configure IP Addresses for VLAN or SuperVLAN Interfaces	160
19.2.7 Configure an IP Address Range for VLAN or SuperVLAN Interfaces	161
19.2.8 Configure the ARP Proxy	162

19.2.9 Display VLAN and SuperVLAN Interface Information	163
19.2.10 Configure URPF	164
19.2.11 Disabling the Function of Sending ICMP Packets with an Unreachable Destination Host on Interfaces	164
Chapter 20 ARP	166
20.1 ARP Overview	166
20.2 Configure ARP	166
20.2.1 ARP Configuration List	166
20.2.2 Add/Delete ARP	167
20.2.3 Bind dynamic Arp to Static	167
20.2.4 Display ARP Entry	167
20.2.5 Configure ARP Aging-time	167
Chapter 21 ARP Spoofing and Flood	169
21.1 ARP Spoofing and Flood Attack Overview	169
21.1.1 ARP against ARP Flood	171
21.2 Configure ARP Anti-Spoofing	172
21.2.1 ARP Anti-Spoofing Configuration List	172
21.2.2 Configure Anti-Spoofing	172
21.2.3 Configure ARP Packet Source MAC Address Consistency Check	173
21.2.4 Configure Anti-Gateway-Spoofing	173
21.3 Configure against ARP Flood	173
21.3.1 ARP against ARP Flood Configuration List	173
21.3.2 Configure against ARP Flood	174
21.3.3 Display and Maintain Against ARP Flood	174
Chapter 22 DHCP-Relay	175
22.1 DHCP-Relay Overview	175
22.2 Configure DHCP-Relay	176
22.2.1 DHCP-Relay Configuration List	176

22.2.2 Configure DHCP Server Group	177
22.2.3 Configure DHCP Relay to Support Option60	177
22.2.4 Enable the DHCP Relay Function	178
22.2.5 Configure DHCP Option82	179
Chapter 23 DHCP Snooping	182
23.1 DHCP Snooping Overview	182
23.2 Configure DHCP Snooping	183
23.2.1 DHCP Snooping Configuration List	183
23.2.2 Enable DHCP Snooping	183
23.2.3 Configure DHCP Snooping Trust port	184
23.2.4 Configure Max Clients Number	184
23.2.5 Configure Link-Down Operation	185
23.2.6 Configure IP-Source-Guard	186
23.2.7 DHCP Snooping Display and Maintenance	187
Chapter 24 DHCP-Server	188
24.1 DHCP-Server Overview	188
24.2 Configure DHCP-Server	188
24.2.1 DHCP-Server Configuration List	188
24.2.2 Configure IP Pool	189
24.2.3 Configure IP Pool Gateway	189
24.2.4 Configure IP Pool Range	190
24.2.5 Enable/Disable IP Address	190
24.2.6 Configure IP Pool Lease	190
24.2.7 Configure the DNS Server Address of DHCP Server	191
24.2.8 Configure the DHCP Server to Assign WINS Server Addresses	191
24.2.9 Display IP Pool Configuration	192
24.2.10 Configure Dhcp-client Bind	192
Chapter 25 IGMP Snooping	194

25.1 IGMP Snooping Overview	194
25.2 IGMP Snooping Configuration	194
25.2.1 IGMP Snooping Configuration List	194
25.2.2 Enable IGMP Snooping	195
25.2.3 Configure IGMP Snooping Timer	196
25.2.4 Configure IGMP-snooping Fast-leave	196
25.2.5 Configure Number of Multicast Group Allowed Learning	197
25.2.6 Configure IGMP Snooping Querier	197
25.2.7 Configure IGMP Snooping Multicast Learning Strategy	199
25.2.8 Configure IGMP Snooping Router-Port	199
25.2.9 Configure IGMP Snooping Port Multicast VLAN	200
25.2.10 Configure Host Port Record MAC Functions	200
25.2.11 Configure Port of Dropped Query Packets	201
25.2.12 Configure Port of Discarded Report Packets	201
25.2.13 Configure Multicast Preview	202
25.2.14 Configure Profile of Black and White List	202
25.2.15 Display and Maintenance of IGMP Snooping	203
Chapter 26 MLD Snooping	205
26.1 MLD Snooping Overview	205
26.2 MLD Snooping	205
26.2.1 MLD Snooping Configuration List	205
26.2.2 Start MLD Snooping	206
26.2.3 Configure MLD Snooping Timer	206
26.2.4 Configure Fast-leave Port	206
26.2.5 Maximum Number of Learning Multicast Configuration Port	207
26.2.6 Configure MLD Snooping Multicast Learning Strategies	208
26.2.7 Configure MLD-Snooping querier	209
26.2.8 Configure Routing Port	210
26.2.9 Multicast VLAN Port Configuration	210

26.2.10 Display and Maintenance of MLD Snooping	211
Chapter 27 Static Multicast Table	212
27.1 Static Multicast Table Overview	212
27.2 Configure Static Multicast Table	212
27.2.1 Static Multicast Group Configuration List	212
27.2.2 Create a Static Multicast Group	212
27.2.3 Add a Port to the Multicast Group	213
27.2.4 Create a Static Multicast Group based on Group IP	213
27.2.5 Display and Maintenance of Static Multicast Table	214
Chapter 28 IGMP	215
28.1 IGMP Overview	215
28.2 Configure IGMP	215
28.2.1 IGMP Configuration List	216
28.2.2 Enable Multicast Routing Protocol	216
28.2.3 Enable IGMP Protocol	217
28.2.4 Configure IGMP Version	217
28.2.5 Configure IGMP General Query Interval	218
28.2.6 Configure Last-Member-Query-Interval	219
28.2.7 Configure Robustness Variable of IGMP Querier	219
28.2.8 Configure the Maximum Number of the Multicast Group Added to the Interface	220
28.2.9 Configure IGMP Maximum Query Response Time	221
28.2.10 Configure Multicast Group Filter Function	222
28.2.11 Establish Static IP Multicast Table	222
28.2.12 Configure Static Multicast Group	223
28.2.13 Configure IGMP Proxy	224
28.2.14 Configure IGMP SSM Mapping	225
28.2.15 Configure SSM-Mapping static group address mapping rule	225
28.2.16 IGMP Display and Maintenance	226

Chapter 29 PIM	227
29.1 PIM Overview	227
29.1.1 Principles of PIM-DM	227
29.1.2 Principles of PIM-SM	230
29.1.3 Principles of PIM-SSM	231
29.2 Configure PIM	232
29.2.1 PIM Configuration List	232
29.2.2 Basic PIM Configuration	232
29.2.3 Advanced PIM Configuration	232
Chapter 30 SNTP	236
30.1 SNTP Overview	236
30.1.1 SNTP Operation Mechanism	236
30.2 Configure SNTP Client	237
30.2.1 SNTP Client Configuration List	237
30.2.2 Enable SNTP Client	237
30.2.3 Modifying SNTP Client Operating Mode	238
30.2.4 Configure SNTP Sever Address	238
30.2.5 Modifying Broadcast Transfer Delay	238
30.2.6 Configure Multicast TTL	239
30.2.7 Configure Interval Polling	239
30.2.8 Configure Overtime Retransmist	239
30.2.9 Configure Valid Servers	240
30.2.10 Configure MD5 Authentication	240
30.2.11 Display and Maintain SNTP Client	241
Chapter 31 802.1X	242
31.1 802.1X Overview	242
31.1.1 Architecture of 802.1X	242
31.1.2 Rule of 802.1x	244
31.2 Configure AAA	246

31.2.1 Configure RADIUS Server	247
31.2.2 Configure Local User	247
31.2.3 Configure Domain	248
31.2.4 Configure RADIUS Features	248
31.3 Configure 802.1X	250
31.3.1 Configure EAP	250
31.3.2 Enable 802.1x	251
31.3.3 Configure 802.1x Parameters for a Port	251
31.3.4 Configure Re-Authentication	252
31.3.5 Configure Watch Feature	252
31.3.6 Configure User Features	253
Chapter 32 LLDP	254
32.1 LLDP Overview	254
32.1.1 LLDP Fundamentals	254
32.1.2 LLDP Timer	254
32.2 Configure LLDP	255
32.2.1 LLDP Configuration List	255
32.2.2 Enable LLDP	255
32.2.3 Configure LLDP Hello-Time	255
32.2.4 Configure LLDP Hold-Time	256
32.2.5 Configure LLDP Packet Transferring and Receiving Mode on Port	256
32.2.6 Configure LLDP Management Address	257
32.2.7 LLDP Display and Debugging	257
Chapter 33 PPPoE Plus	258
33.1 PPPoE Plus Overview	258
33.2 Configure PPPoE Plus	258
33.2.1 PPPoE Plus Configuration List	258
33.2.2 Enable PPPoE Plus	258

33.2.3 ConfigureOption Content	259
33.2.4 PPPoE Plus Monitor and Maintenance	260
Chapter 34 CFM	261
34.1 CFM Overview	261
34.1.1 CFM Concepts	261
34.1.2 CFM Main Function	262
34.2 Configure CFM	263
34.2.1 CFM Configuration List	264
34.2.2 Maintain Field Configuration	264
34.2.3 Configuration and Maintenance Level Domain Name	264
34.2.4 Configure Maintain Set	265
34.2.5 Configure Name and Associated VLAN to Maintain Set	266
34.2.6 Configure MEPs	266
34.2.7 Configure Remote Maintenance Endpoint	267
34.2.8 Configure MIPs	268
34.2.9 Configure Continuity Detection	268
34.2.10 Configure Loopback	269
34.2.11 ConfigureLink Tracking	270
34.2.12 Display and Maintenance of CFM	270
Chapter 35 EFM	272
35.1 EFM Overview	272
35.1.1 EFM Main Function	272
35.1.2 EFM Protocol Packets	274
35.2 Configure EFM	274
35.2.1 EFM Configuration List	274
35.2.2 EFM Basic Configuration	275
35.2.3 Configure EFM Timer Parameter	276
35.2.4 Configure Remote Failure Indication	277
35.2.5 Configure Link Monitoring Capabilities	277

35.2.6 Enabling Remote Loopback	279
35.2.7 Rejecting Remote Loopback Requests Initiated by Remote	279
35.2.8 Initiating a Remote Loopback Request	280
35.2.9 Starting Remote Access Function MIB Variable	280
35.2.10 MIB Variable Access Requests Initiated by Remote	281
35.2.11 Display and Maintenance of EFM	282
Chapter 36 ERRP	283
36.1 ERRP Overview	283
36.1.1 Concept Introduction	283
36.1.2 Protocol Message	287
36.1.3 Operate Principle	289
36.1.4 Multi-loop Intersection Processing	293
36.2 Configure ERRP	293
36.2.1 ERRP Configuration List	293
36.2.2 Enable/Disable ERRP	294
36.2.3 Configure Time Parameter	294
36.2.4 Configure Domain	295
36.2.5 Configure Work Mode	295
36.2.6 Configure Control VLAN	296
36.2.7 Configure the Ring	297
36.2.8 Enable/Disable ERRP Ring	298
36.2.9 Configure the Query Solicit Function	298
36.2.10 Configure the Topology Discovery Function	299
36.2.11 Display and Maintenance of ERRP	300
Chapter 37 ERPS	301
37.1 ERPS Overview	301
37.1.1 ERPS Basic Conception	301
37.1.2 ERPS Ring Protection Mechanism	304
37.2 Configure ERPS	306

37.2.1 ERPS Configuration List	306
37.2.2 Enable/Disable ERPS	306
37.2.3 Configure ERPS Instance	307
37.2.4 Configure Connectivity Detection of ERRP Link	308
37.2.5 Configure ERPS Related Timers	308
37.2.6 ERPS Display and Maintenance	309
Chapter 38 FlexLink	310
38.1 FlexLink Overview	310
38.1.1 Basic Concept of Flex Links	310
38.1.2 Operating Mechanism of Flex Link	311
38.2 Configure FlexLinks	314
38.2.1 FlexLinks Configuration List	314
38.2.2 Configure FlexLinks group	315
38.2.3 Configure FlexLinks Preemption Mode	315
38.2.4 Configure FlexLinks Preemption Delay	316
38.2.5 Configure FlexLinks MMU	317
38.2.6 FLexLinks Monitor and Maintenance	317
Chapter 39 Monitorlink	318
39.1 Monitorlink Overview	318
39.1.1 Monitor Link Group	318
39.1.2 Monitor Link Mechanism	320
39.2 Configure Monitor Link	322
39.2.1 MonitorLink Configuration List	322
39.2.2 Configure MonitorLink Group	322
39.2.3 MonitorLink Monitor and Maintenance	323
Chapter 40 L3 Base Function Configuration	324
40.1 L3 Base Function Overview	324
40.2 ConfigureL3 Base Function	324
40.2.1 L3 Base Function Configuration List	324

40.2.2 Planning VLANs and Creating L3 Interfaces	325
40.2.3 Configure the Forwarding Mode	325
40.2.4 Creating VLAN Interfaces for Common VLANs	326
40.2.5 Creating SuperVLAN Interfaces and Adding VLANs to the SuperVLAN	327
40.2.6 Configure IP Addresses for VLAN or SuperVLAN Interfaces	328
40.2.7 Configure an IP Address Range for VLAN or SuperVLAN Interfaces	329
40.2.8 Configure the ARP Proxy	330
40.2.9 Display VLAN and SuperVLAN Interface Information	331
40.2.10 Configure URPF	332
40.2.11 Disabling the Function of Sending ICMP Packets with an Unreachable Destination Host on Interfaces	333
Chapter 41 Static Route Configuration	334
41.1 Static Route Overview	334
41.2 Configure Static Route	334
41.2.1 Static Route Configuration List	334
41.2.2 Adding/Deleting a Static Route	334
41.2.3 Display Routing Entries	335
Chapter 42 RIP	337
42.1 RIP Overview	337
42.2 Configure RIP	339
42.2.1 RIP Configuration List	339
42.2.2 Enabling RIP	340
42.2.3 Specifying the IP Network Segment to Run RIP	340
42.2.4 Configure the Passive interface	341
42.2.5 Specifying the RIP Version for an Interface	341
42.2.6 Configure Default Metric Value	343
42.2.7 Enabling the Route Aggregation Function	343

42.2.8 Configure RIP Packet Authentication	344
42.2.9 Configure Split Horizon	344
42.2.10 Setting an Additional Routing Metric	345
42.2.11 Defining a Prefix List	346
42.2.12 Configure Route Redistribution	347
42.2.13 Configure Route Filtering	348
42.2.14 Display RIP Configuration	349
Chapter 43 OSPF	351
43.1 OSPF Overview	351
43.2 Configure OSPF	353
43.2.1 OSPF Configuration List	353
43.2.2 Enable OSPF	353
43.2.3 Configure OSPF Parameter	353
43.2.4 Configure OSPF Interface	354
43.2.5 Configure OSPF Area	359
Chapter 44 BGP	363
44.1 BGP Overview	363
44.2 Configure BGP	366
44.2.1 BGP Configuration List	366
44.2.2 Enable BGP	366
44.2.3 Configure BGP Peers	367
44.2.4 Configure BGP Parameters	369
44.2.5 Monitoring and Maintain BGP	371
Chapter 45 BFD	372
45.1 BFD Overview	372
45.2 Configure BFD	372
45.2.1 BFD Configuration List	372
45.2.2 Enable BFD	372
45.2.3 Configure BFD Parameters and Mode	373

45.2.4 Display and Maintain BFD Configurations	375
Chapter 46 VRRP	376
46.1 VRRP Overview	376
46.2 Configure VRRP	377
46.2.1 VRRP Configuration List	377
46.2.2 Enable VRRP	377
46.2.3 Configure VRRP Parameters	378
46.2.4 Displays and Maintain VRRP Configurations	381
Chapter 47 DLF-Control	382
47.1 DLF-Control Overview	382
47.2 Configure DLF-Control	382
47.2.1 DLF-Control Configuration List	382
47.2.2 Configure DLF-forward unicast	382
47.2.1 Configure DLF-forward multicast	383
47.2.2 Displays and Maintain DLF-forward Configurations	383
Chapter 48 SLF-Control	384
48.1 SLF-Control Overview	384
48.2 Configure SLF-Control	384
48.2.1 SLF-Control Configuration List	384
48.2.2 Configure SLF-forward unicast	384
48.2.3 Displays and Maintain SLF-forward Configurations	385
Chapter 49 BPDU-Discard	386
49.1 BPDU-Discard Overview	386
49.2 Configure BPDU-Discard	386
49.2.1 BPDU-Discard Configuration List	386
49.2.2 Configure BPDU-Discard	386
49.2.3 Displays and Maintain BPDU-Discard Configurations	387
Chapter 50 BPDU-Tunnel	388
50.1 BPDU-Tunnel Overview	388

50.2 Configure BPDU-Tunnel	389
50.2.1 BPDU-tunnel Configuration List	389
50.2.2 Configure BPDU-Tunnel Packet	389
50.2.3 Configure BPDU-Tunnel Destination MAC	389
50.2.4 Displays and Maintain BPDU-Tunnel Configuration	390
Chapter 51 Local-Switch	391
51.1 Local-Switch Overview	391
51.2 Configure Local-Switch	391
51.2.1 Local-switch Configuration List	391
51.2.2 Enable local-switch	391
51.2.3 Displays and Maintain Local-switch Configurations	392
Chapter 52 Port&CPU Utilization Alarm	393
52.1 Port&CPU Utilization Alarm Overview	393
52.2 Configure Port&CPU Utilization Alarm	393
52.2.1 Port & CPU Utilization Alarm Configuration List	393
52.2.2 Configure Port Utilization Alarm	394
52.2.3 Configure CPU Utilization Alarm	394
52.2.4 Display and Debugging Device Utilization Alarm	395
Chapter 53 Configure ONT Discovery	396
53.1 ONT Discovery Overview	396
53.2 Configure ONT Discovery	396
53.2.1 Comfigure ONT Discovery	396
53.2.2 Configure ONT Silent	397
Chapter 54 Configure ONT Profile	399
54.1 ONT Profile Overview	399
54.2 Configure Alarm Profile	399
54.3 Configure DBA Profile	400
54.4 Configure Downstream Profile	401
54.5 Configure Line Profile	402

54.6 Configure Multicast Profile	403
54.7 Configure Rule Profile	404
54.8 Configure Specific Profile	406
54.9 Configure Upstream Profile	408
54.10 Configure VLAN Profile	408
Chapter 55 ONT System Management	410
55.1 ONT System Management Overview	410
55.2 Configure ONT System Management	410
55.2.1 ONT Reboot	410
55.2.2 ONT Upgrade	410
55.2.3 ONT Activation	411
55.2.4 ONT Auto-configuration	412
55.2.5 ONT Configuration Reset	412
55.3 ONT Log Management	413
Chapter 56 Display ONT Information	414
56.1 Display ONT Information	414
56.1.1 Display ONT Optical Power	414
56.1.2 Display ONT Traffic Statistics	414
56.1.3 Display ONT Port Status	414
56.1.4 Display ONT Multicast	415
56.1.5 Display ONT details	415
56.1.6 Display ONT Profile	416
56.1.7 Display ONT Description	416
56.1.8 Display ONT Upgrade Status	416
56.1.9 Display ONT Version	416
56.1.10 Display ONT MAC	416
56.1.11 Display ONT Capability	417
56.1.12 Display ONT PoE Feature	417
56.1.13 Display Rogue ONT Detection	417

Chapter 1 Access OLT

1.1 CLI

You can access GPON in the following ways:

1. Perform local configuration through the Console port, the serial port baud rate is 115200, set as shown in the figure below:

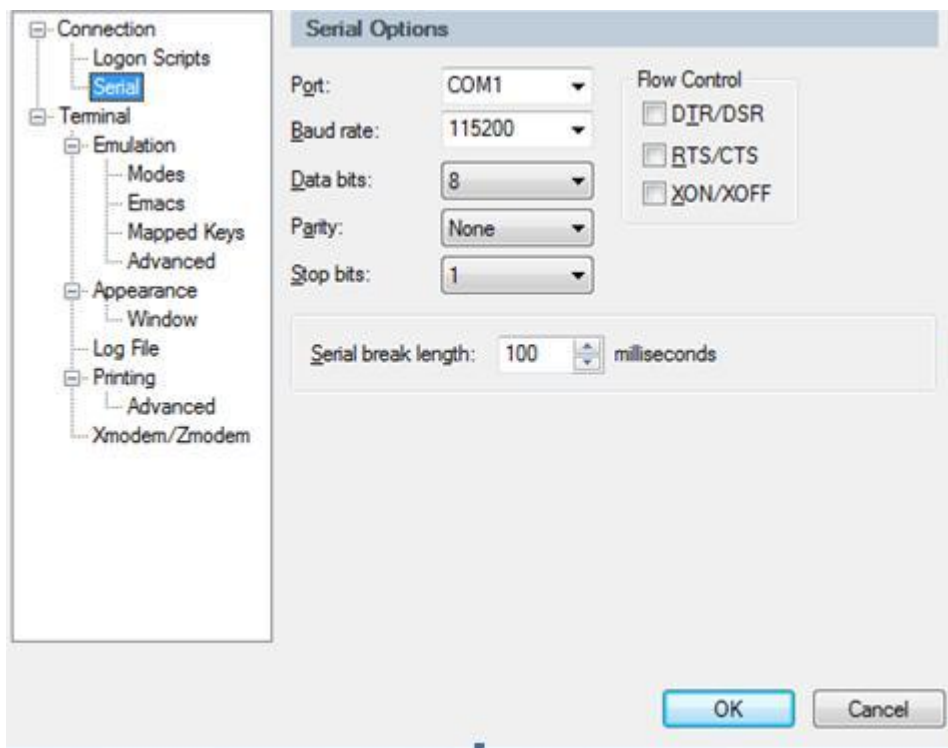

2. Local or remote configuration by Telnet/SSH;

3、 Provide FTP, TFTP, Xmodem services to facilitate users to upload and download files.

1.1.1 Command Syntax

The login verification of the system console of this OLT is mainly used to verify the identity of the operating user. The matching identification of the name and password to allow or deny the user's login.

Step 1: When entering the command line interface, the following login prompt appears:

Login:

Please enter the login user name, press Enter, and then enter the password:

After entering the correct login password, you can enter the normal user view:

GPON>

There are two different permissions, one for administrator permissions and the other for ordinary user permissions.

Ordinary users can only view and have no right to modify, but the administrator can manage and configure the GPON.

If you log in as a system administrator, you will enter the privileged user view:

GPON>enable

Step 2: After typing the complete command, press Enter

E.g:

!The user does not need to enter parameters

[GPON]quit

"quit" is a command without parameters. After typing this command, press Enter to execute the command.

!Need to enter parameters

[GPON]vlan 100

The command keyword is vlan and the parameter value is 100.

1.1.2 Help of Command Line

There is a built-in syntax help in the command line interface. In any command mode, type "?" or use the help command to get all the commands in the command mode and their brief descriptions.

E.g:

1.Type "?" directly in the privileged user view

<GPON>?

 Commands of system mode:

 clear clear erps-ring's statistics
 cls clear screen
 display display running system information

2. Type "?" immediately after the keyword

[GPON]interf?

interface

3. Type a space after the command line string and add "?"

```
[GPON]stp ?
```

```
forward-time  config  delaytime
```

```
hello-time    config  hellotime
```

```
max-age       config  max agingtime
```

```
priority      config  priority
```

```
<enter>      The command end.
```

4. Parameter range or format

```
[GPON]stp forward-time ?
```

```
INTEGER<4-30>  delaytime: <4-30>(second)
```

5. Prompt for the end of the command line

```
[GPON] stp ?
```

```
<enter>      The command end.
```

1.1.3 Display history Command of Command Line

Command line interface provides the function similar to that of DosKey. The commands entered by users can be automatically saved by the command line interface and you can invoke and execute them at any time later. History command buffer is defaulted as 100. That is, the command line interface can store 100 history commands for each user, you can type "up arrow" or "Ctrl+P", and access the next command can type "down arrow" or "Ctrl+N".

1.2 Manage Users

The system provides two user permissions:

-Admin administrator

-Normal user

The normal users can only be in the user's mode after logging in the GPON so they can only check the basic information about operation and statistics; administrator can enter each configuration mode to check and manage the system.

1.2.1 System Default User

There is an internal username with password called Super-administrator. It processes the superior priority in the GPON to manage both the users and the GPON.

The username of Super-administrator is admin and its initial password is admin. It is suggested modifying the password after the initial-logging in. This username and its administrator privilege cannot be deleted and modified.

1.2.2 Add User

Operation	Command	Remarks
Enter super user view	enable	
Enter global configuration mode	system-view	
Add Account	terminal user <i>username</i> [privilege level] { password encryption-type password }	
display user	display terminal user	

username: the username of the newly added user, The length is 1 to 32 characters, must be characters, and cannot contain '/', ':', '*', '?', '\\', '<', '>', '|', ''

privilege: User authority, the value range is 0~15. 0~1 means normal user; 2~15 means administrator

encryption-type: The value is 0 or 7, 0 means that the password is set in plain text, and 7 means that the password is set in cipher text

password: Login password, the length is 1-16 characters.

Example:

!Create the administrator user “test”, the password is test, and the privilege level is 15

```
[GPON]terminal user test privilege 15 password 0 test
```

Notice:

Username is not case sensitive, password is case sensitive;

Only the system administrator admin user can delete user accounts, other users cannot delete users;

The system administrator admin can modify the password of himself or other users, and other administrator users can only modify their own passwords;

1.2.3 Change Password

Operation	Command	Remarks
Enter super user view	enable	
Enter global configuration mode	system-view	
Change password	terminal user change-password	

Example:

!Change the password of user “test” to 1234

[GPON] terminal user change-password

please input you login password : *****

please input username :test

Please input user new password :****

Please input user comfirm password :****

change user test password success.

1.2.4 Modify User's Privilege Level

Operation	Command	Remarks
Enter super user view	enable	
Enter global configuration mode	system-view	
Modify user Privilege Level	terminal user <i>username</i> [privilege level] { password <i>encryption-type password</i> }	

Example:

!Modify the privilege of the existed user “test” to 1, and the password totest

[GPON] terminal user test privilege 1 password 0 test

1.2.5 Delete User

Operation	Command	Remarks
Enter super user view	enable	
Enter global configuration mode	system-view	
Delete user	undo terminal user <i>username</i>	

Example:

!Delete user “test”

[GPON]undo terminal username test

1.2.6 Display Users

Operation	Command	Remarks
Display user	display terminal user [<i>username</i>]	

【Example】

! Display the information of user “test”

[GPON]display terminal user test

1.2.7 Display Users

Operation	Command	Remarks
Display user	display login-users	

【Example】

! Display the information of user “test”

[GPON]display login-users

1.2.8 Kick off Online Telnet Users

Operation	Command	Remarks
Enter super user view	enable	
Kick off online telnet users	remote-stop <i>username</i>	

【Example】

! Kick off online telnet users “test”

<GPON>remote-stop test

1.3 Remote Authentication Configure

User accounts can be stored in the local database of the GPON or in RADIUS/TACACS+ server, The system uses the local database by default.

Notice:

The admin user only supports the authentication method of the local database.

1.3.1 Enable RADIUS/TACACS+

Operation	Command	Remarks
Enter global configuration mode	system-view	
Enable Radius/Tacacs	user-auth { local { radius <i>radiusname</i> { pap chap } [local] } } { tacacs+ [author] [account] [local] }	The default is local authentication

1.3.2 Display Authentication Method

Operation	Command	Remarks
Display authentication method	display user-auth	

1.3.3 TACACS+ Remote Server Configuration

Operation	Command	Remarks
Enter global configuration mode	system-view	

Configure Tacacs+Remote Server	tacacs+ { primary secondary } server <i>ipaddress</i> [key <i>keyvalue</i>] [port <i>portnum</i>] [timeout <i>timevalue</i>]	
--------------------------------	--	--

1.3.4 Dsisplay TACACS+ Information

Operation	Command	Remarks
Dsisplay TACACS+ information	display tacacs+	

Chapter 2 System Management

2.1 System Maintenance

2.1.1 Display System Status Information

Operation	Command	Remarks
Display version information	display version	
Display user information	display local-user	
Display logged-in user information	display login-users	
Display system memory information	display memory	
Display system clock	display time	
Display system CPU utilization	display cpu-info	

【Example】

! Display system version

```
[GPON]display version
```

2.1.2 Configure the System Clock

Operation	Command	Remarks
Enter super user view	enable	
Set system clock	time HH:MM:SS YYYY/MM/DD	
Enter global configuration mode	system-view	

Set clock timezone	time zone name hour minute	
display system time	display time	

【Example】

! Set the system clock to 8:30: 0 on October 1, 2020

```
<GPON>time 08:30:0 2020/10/01
```

2.1.3 Configure System Host Name

Operation	Command	Remarks
Enter super user view	enable	
Enter global configuration mode	system-view	
Configure the host name	sysname sysname	
Delete the host name	undo sysname	

【Example】

! Set the host name to GPON-ABCD

```
[GPON]sysname GPON-ABCD
```

```
[GPON-ABCD]
```

2.1.4 Trace Route Command

Support tracert command and check network connection. The tracert command can be executed in any view:

Operation	Command	Remarks
Tracert test	tracert [-u -c] [-p <i>udpport</i> -f <i>first_ttl</i> -h <i>maximum_hops</i> -w <i>time_out</i>] <i>target_name</i>	

【Parameter Description】

-u: Send udp message;

-c: Send echo message of icmp;

-p *udpport*: The destination port , the value range is 1-65535, the default port is 62929;

-f *first_ttl*: The initial ttl value, the value range is 1-255, the default value is 1;

-h *maximum_hops*: The maximum ttl value, the value range is 1-255, the default value is 30;

-w *time_out*: The timeout period for waiting for a response, the value range is 10-60 seconds, and the default value is 10 seconds;

target_name: Destination host or router address

【Example】

! Trace the route that can reach 192.168.1.2

```
<GPON>tracert 192.168.1.2
```

2.1.5 Port Loopback Test Command

The system supports port loopback test function, used to test the internal and external connectivity of the port:

Operation	Command	Remarks
Enter global configuration mode	system-view	
Loopback test on all ports	loopback { internal external }	

Enter interface view	interface { { ethernet <i>interface-num</i> } <i>interface-name</i> }	
Loopback test on a single port	loopback { internal external }	

2.1.6 Line Detection VCT Command

VCT is used to detect network cable normal (NORMAL), open circuit (OPEN), short circuit (SHORT), impedance mismatch (IMPEDANCE MISMATCH) and other error conditions.

The normal connection of the network cable is NORMAL, the disconnection of the network cable is OPEN, and the short circuit of the network cable is SHORT. Impedance mismatch (IMPEDANCE MISMATCH) generally occurs when two network cables with different impedances are connected together. If an error is found, the location of the error can be detected. The longest detection distance of VCT is 181 meters for 100M ports and 175 meters for Gigabit ports:

Operation	Command	Remarks
Enter global configuration mode	system-view	
Perform VCT detection on all ports	vct run	
Enter interface view	interface { { ethernet <i>interface-num</i> } <i>interface-name</i> }	
Perform VCT detection on a single port	vct run	

【Example】

! VCT test on Ethernet port 1

```
[GPON-ethernet-0/1]vct run
```

Notice:

VCT detection is only for Cat 5 Ethernet ports and does not support VCT detection on optical fiber ports.

2.1.7 Management IP Address Configuration

You can restrict the host IP address or a certain network segment that log in to the GPON's web, telnet, snmp agent, and other IP addresses other than the matching configuration cannot manage the Olt.

Operation	Command	Remarks
Enter global configuration mode	system-view	
Configure management IP address restrictions	login-acl { web snmp telnet } <i>ip-address wildcard</i>	
Remove management IP address restrictions	undo login-acl { all { web snmp telnet { all ip-address wildcard } } }	
Display management IP address restriction configuration information	display login-acl	

【Example】

! The configuration only allows addresses in the network segment 192.168.0.0/255.255.0.0 to access the Olt through telnet

```
[GPON] login-acl telnet 192.168.0.1 0.0.255.255
```

```
[GPON]undo login-acl telnet 0.0.0.0 255.255.255.255
```

! Display the configuration of the management ip address restriction:

```
[GPON]display login-acl
```

2.1.8 Telnet User Limit for Login Privileged User View

Operation	Command	Remarks
Enter global configuration mode	system-view	
Configure the number of Telnet users	telnet-server limit <i>limit-num</i>	
Remove the limit on the number of users logging in to Telnet	undo telnet-server limit	
Display Telnet user limit configuration information	display telnet-server	

【Example】

! Configure to allow only two Telnet users to enter privileged user view at the same time

```
[GPON] telnet-server limit 2
```

2.1.9 CPU-CAR Command

CPU-CAR is mainly used to set the rate at which the CPU receives packets to limit the number of packets sent to the CPU per second.

Operation	Command	Remarks
Enter global configuration mode	system-view	
Configure CPU-CAR	cpu-car target_rate	
Restore the default CPU-CAR Value	undo cpu-car	
Display CPU-CAR	display cpu-car	

【Example】

! Set the rate of cpu receives packets to 100pps

```
[GPON]cpu-car 100
```

2.2 Configuration Management

2.2.1 Save Configurations

After modified the configurations, you should save them so that these configurations can take effect next time it restarts. Use the following commands to save configurations.

Operation	Command	Remarks
Enter super user view	enable	
Save configurations	save current-config	

2.2.2 Erase Configurations

If you need to reset to factory default, you can use the following commands to erase all configurations. After erased, the device will reboot automatically.

Operation	Command	Remarks
Enter super user view	enable	
Erase configuration	clear save-config	

2.2.3 Execute save Configuration

Operation	Command	Remarks
Enter super user view	enable	
Execute save configuration	update current-config	

2.2.4 Show save Configurations

Use the following command to display the configurations you have saved.

Operation	Command	Remarks
Show configuration	display save-config [<i>module-list</i>]	

【 Example 】

! Display all contents of the configuration file

```
<GPON>display save-config
```

! Display the contents of GARP and OAM modules in the configuration file

```
<GPON>display save-config garp oam
```

2.2.5 Show Running Configurations

Operation	Command	Remarks
Show running configurations	display current-config [<i>module-list</i>] [perlines <i>num</i>]	

【Example】

! Display all configuration information

```
<GPON>display current-config
```

! Display configuration information for vlan

```
<GPON>display current-config vlan
```

2.3 Load Files and Upgrade Programs Online

2.3.1 Upload and Download Files by TFTP

Operation	Command	Remarks
Enter super user view	enable	
upload files	upload { configuration info-center } tftp <i>tftpserver-ip filename</i>	configuration is the system save configuration file. info-center is the system log file
download file	load { configuration host bootrom cpld-image http { private-key server-certificate } ont-image } tftp <i>tftpserver-ip filename</i>	configuration is the system save configuration file. application is the device upgrade host program. whole-bootrom is the bootrom program for the device

tftpserver-ip is the IP address of the TFTP server, and filename is the name of the file to be uploaded. Before entering the command, open the TFTP server and set the destination path for the file upload.

【Example】

! Upload the configuration file by TFTP and name the configuration file config.txt

```
<GPON>upload configuration tftp 192.168.1.100 config.txt
```

After the upload is successful, the file config.txt in the computer with the IP address of 192.168.1.100 saves the current configuration.

! Download the configuration file config.txt by TFTP,

```
<GPON>load configuration tftp 192.168.1.100 config.txt
```

After downloading successfully and restarting the system, the system will use the new configuration file config.txt

! Upload the log file by TFTP and name the log file log.txt

```
<GPON>upload info-center tftp 192.168.1.100 log.txt
```

! Download the upgrade file host.bin by TFTP

```
<GPON>load host tftp 192.168.1.100 host.bin
```

After downloading successfully and restarting the system, host.bin will run.

! Download the bootrom program boot.bin by TFTP

```
<GPON>load bootrom tftp 192.168.1.100 boot.bin
```

2.3.2 Upload and Download Files by FTP

Operation	Command	Remarks
-----------	---------	---------

Enter super user view	enable	
upload files	upload { configuration info-center } ftp <i>ftpserver-ip filename username password</i>	
download file	load { configuration host bootrom cpld-image http { private-key server-certificate } ont-image } ftp <i>ftpserver-ip filename username password</i>	

ftpserver-ip is the IP address of the FTP server, and filename is the name of the file to be uploaded. username and userpassword are the username and password set in the FTP server. Before entering the command, you should open the FTP server, and set the user name, password, and the destination path of the file upload.

【Example】

! Upload the configuration file by FTP and name the configuration file config.txt

```
<GPON>upload configuration ftp 192.168.1.100 config.txt admin 123
```

! Download configuration files by FTP

```
<GPON>load configuration ftp 192.168.1.100 config.txt admin 123
```

! Download the upgrade file host.bin by ftp

```
<GPON>load host ftp 192.168.1.100 host.bin admin 123
```

! Upload the log file by FTP and name the log file log.txt

```
<GPON>upload info-center ftp 192.168.1.100 log.txt admin 123
```

! Download the bootrom program boot.bin by FTP

```
<GPON>load bootrom ftp 192.168.1.100 boot.bin admin 123
```

2.3.3 Download Files by Xmodem

Operation	Command	Remarks
Enter super user view	enable	
download file	load { configuration host bootrom } xmodem	

After entering the command, select "Transfer" ->"Send File" in the HyperTerminal menu, and enter the full path and file name of the file in the "File Name" column of the "Send File" dialog box that pops up, and the "Protocol" drop-down Select Xmodem in the list, and then click the [Send] button.

【Example】

! Download the host program by Xmodem

```
<GPON>load application xmodem
```

2.4 Reboot OLT

Operation	Command	Remarks
Enter super user view	enable	
Restart the GPON immediately	reboot	
Enter system view	system-view	
Auto restart at specified time	auto-reboot { in { minutes <i>min</i> hours <i>hour</i> } at { YYYY/MM/DD <i>hh:mm:ss</i> <i>hh:mm:ss</i> daily }	

	<i>hh:mm:ssweekday weekly }</i> }	
Cancel scheduled automatic restart	undo auto-reboot	

【Example】

! Set to restart at 03:30:30 on May 15, 2020

[GPON]auto-reboot at 03:30:30 2020/05/15

! Set to restart at 03:30:30 every Monday morning

[GPON]auto-reboot at 03:30:30 mon weekly

Chapter 3 Port Configuration

3.1 Ethernet Port Configuration Overview

The gigabit port of the OLT supports 10/100/1000Base-T. The port can work in half-duplex and full-duplex modes. It can negotiate with other network equipment to determine the working mode and rate, and automatically select the most suitable working mode and rate. Simplified system configuration and management. The 10G optical port supports 1000M, 10000Mbps full-duplex speed mode. The PON port has a fixed rate and does not support rate configuration

3.2 Configure Ethernet Port

3.2.1 Enter Interface Configuration Mode

Operation	Command	Remarks
Enter global configuration mode	system-view	
Enter interface configuration mode.	interface { { ethernet <i>interface-num</i> } <i>interface-name</i> }	

3.2.2 Enter Interface Range Mode

Operation	Command	Remarks
Enter global mode	system-view	
Enter interface range	interface range { { ethernet <i>interface-list</i> }	

mode.	<i>interface-name</i> }	
-------	-------------------------	--

【Example】

! Enter interface range configuration mode, this range includes Ethernet 1~3

[GPON]interface range ethernet 0/0/1 to e 0/0/3

[GPON-port-range]

3.2.3 Basic Port Configuration

Operation	Command	Remarks
Enter global mode	system-view	
Enter interface mode	interface { { ethernet <i>interface-num</i> } <i>interface-name</i> }	
Disable specific port	shutdown	
Enable specific port	undo shutdown	
Configure speed of a port	speed { 10 100 1000 10000 auto }	
Configure default duplex of a port	undo speed	
Configure duplex of a port	duplex { full half }	
Configure priority of a port	priority <i>priority-num</i>	
Configure default priority of a port	undo priority	
Configure port description	description <i>description-list</i>	
Delete port description	undo description	
Enable ingress filtering	ingress filtering	

Disable ingress filtering	undo ingress filtering	
Enable ingress acceptable-frame	ingress acceptable-frame { all tagged }	
Disable ingress acceptable-frame	undo ingress acceptable-frame	
Enable Ethernet port flow control	flow-control	
Disable Ethernet port flow control	undo flow-control	
Display port flow control function	display flow-control interface [ethernet interface-num]	

3.2.4 Link Type of Ethernet Ports

An Ethernet port can operate in one of the three link types:

Access: An access port only belongs to one VLAN, normally used to connect user device.

Trunk: A trunk port can belong to more than one VLAN. It can receive/send packets from/to multiple VLANs and is generally used to connect another GPON. The packet sent from this port can be with or without the tag label.

Hybrid: A hybrid port can belong to multiple VLANs, can receive, or send packets for multiple VLANs, used to connect either user or network devices. It allows packets of multiple VLANs to be sent with or without the tag label

Operation	Command	Remarks
Enter global mode	system-view	
Enter interface mode	interface { { ethernet interface-num } interface-name }	

Set port link type	port mode { trunk hybrid access }	
Configure default link type	undo port mode	The default port type is Hybrid

【Example】

! Set Ethernet port 1 as a trunk port

[GPON-ethernet-0/0/1]port mode trunk

3.2.5 Configure Default VLAN

Operation	Command	Remarks
Enter global mode	system-view	
Enter interface mode.	interface { { ethernet <i>interface-num</i> } <i>interface-name</i> }	
Set port default vlan id	port default vlan <i>vlan-id</i>	
Restore port default vlan id	undo port default vlan	

【Example】

! Set the default VLAN ID of Ethernet 0/1 to 5

[GPON-ethernet-0/0/1] port default vlan 5

3.2.6 Add Port to a Vlan

Operation	Command	Remarks
Enter global mode	system-view	

Enter interface mode	interface { { <i>ethernet interface-num</i> } <i>interface-name</i> }	
Configure the port mode as access	port mode access	
Add the Access port to the specified vlan	port default vlan <i>vlan-id</i>	
Configure the port mode as Hybrid	port mode hybrid	
Add Hybrid port to specific VLAN and keep the packet VID	port hybrid tagged vlan { all <i>vlan-list</i> }	
Add Hybrid port to specific VLAN and strip the packet VID	port hybrid untagged vlan { all <i>vlan-list</i> }	
Delete Hybrid port from specific VLAN	undo port hybrid vlan { all <i>vlan-list</i> }	
Configure the port mode as Trunk	port mode trunk	
Add Trunk port to specific VLAN	port trunk allowed vlan { all <i>vlan-list</i> }	
Delete Trunk port from specific VLAN	undo port trunk allowed vlan { all <i>vlan-list</i> }	

3.2.7 Display Port Information

Operation	Command	Remarks
Display port information	display interface [ethernet <i>interface-num</i>]	
Display summary information of all ports	display interface brief	

Display port sfp information	display interface sfp [ethernet <i>interface-num</i>]	
------------------------------	--	--

3.2.8 Display and Clear Port Statistics

Operation	Command	Remarks
Display port statistics	display statistics interface [ethernet <i>interface-num</i>]	
Display all port statistics	display statistics interface brief	
Display real-time sending and receiving rates and band utilization	display utilization interface	
Enter global mode	system-view	
Clear port statistics	clear interface [ethernet <i>interface-num</i>]	
Enter interface mode	interface { { ethernet <i>interface-num</i> } <i>interface-name</i> }	
Clear port statistics	clear interface	

Chapter 4 Port Mirroring

4.1 Port Mirroring Overview

Mirroring refers to the process of copying packets that meet the specified rules to a destination port. Generally, a destination port is connected to a data detect device, which users can use to analyze the mirrored packets for monitoring and troubleshooting the network.

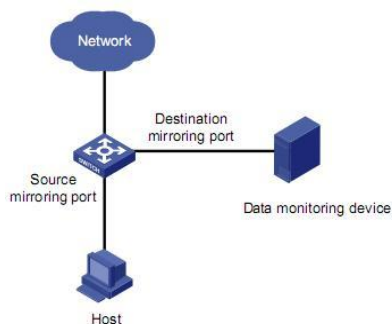

4.2 Configure Port Mirroring

4.2.1 Configure Port Mirroring

The source port is specified and whether the packets to be mirrored are ingress or egress is specified: ingress: only mirrors the packets received via the port; egress: only mirrors the packets sent by the port; both: mirrors the packets received and sent by the port at the same time.

The destination port is specified.

4.2.2 Configure the Mirror Destination Port

Operation	Command	Remarks
Enter global mode	system-view	
Configure destination port (so called monitor port)	mirror group <i>group-id</i> destination-interface ethernet <i>interface-num</i>	
Delete destination monitor port	undo mirror group { all <i>group-id</i> destination-interface ethernet <i>interface-num</i> }	

4.2.3 Configure the Mirror Source Port

Operation	Command	Remarks
Enter global mode	system-view	
Configure source port	mirror group <i>group-id</i> source-interface { ethernet cpu } <i>interface-list</i> { both egress ingress }	
Delete source monitor port	undo mirror group { all <i>group-id</i> source-interface { cpu <i>interface-list</i> } }	

【Example】

! Configure Ethernet ports 1 and 2 as mirror source ports

[GPON] mirror group 1 source-interface ethernet 0/0/1 to ethernet 0/0/2 both

4.2.4 Display Port Mirroring

Operation	Command	Remarks
Display port mirroring	display mirror group { all <i>group-id</i> }	

【Example】

! Display port mirroring

<GPON>display mirror group all

Chapter 5 Link Aggregation

5.1 Link Aggregation Overview

Link aggregation means aggregating several ports together to form an aggregation group, so as to implement outgoing/incoming load sharing among the member ports in the group and to enhance the connection reliability.

Depending on different aggregation modes, aggregation groups fall into two types: static LACP and dynamic LACP. Depending on whether or not load sharing is implemented, aggregation groups can be load-sharing or non-load-sharing aggregation groups.

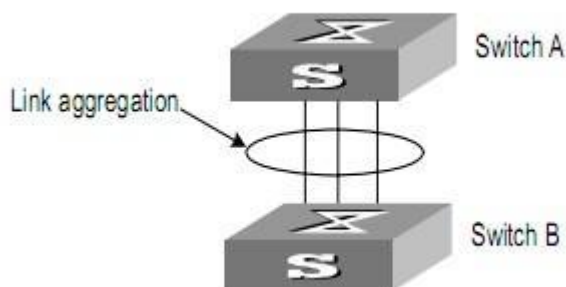

For the member ports in an aggregation group, their basic configuration must be the same. The basic configuration includes STP, QoS, VLAN, port attributes, and other associated settings.

- STP configuration, including STP status (enabled or disabled), link attribute (point-to-point

or not), STP priority, maximum transmission speed, loop prevention status.

- QoS configuration, including traffic limiting, priority marking, default 802.1p priority, traffic monitor, traffic redirection, traffic statistics, and so on.
- VLAN configuration, including permitted VLANs, and default VLAN ID, tag vlan list for hybrid port and allowed vlan list for trunk port.

Port attribute configuration, including port rate, duplex mode, and link type (Trunk, Hybrid or Access). The ports for a static aggregation group must have the same rate and link type, and the ports for a dynamic aggregation group must have the same rate, duplex mode (full duplex) and link type.

5.1.1 Introduction to LACP

The purpose of link aggregation control protocol (LACP) is to implement dynamic link aggregation and disaggregation. This protocol is based on IEEE802.3ad and uses LACPDUs (link aggregation control protocol data units) to interact with its peer.

After LACP is enabled on a port, LACP notifies the following information of the port to its peer by sending LACPDUs: priority and MAC address of this system, priority, number and operation key (it is so called O-Key) of the port. Upon receiving the information, the peer compares the information with the information of other ports on the peer device to determine the ports that can be aggregated with the receiving port. In this way, the two parties can reach an agreement in adding/removing the port to/from a dynamic aggregation group.

5.1.2 Operation Key (O-Key)

An operation key of an aggregation port is a configuration combination generated by system depending on the configurations of the port (rate, duplex mode, other basic configuration, and administrative key) when the port is aggregated.

- 1) The ports in the same aggregation group must have the same operation key (O-Key) and administrative key (A-Key).
- 2) The administrative key (A-Key) and operation key (O-Key) of an LACP-enable aggregation port is equal to its aggregation group ID+1.
- 3) The administrative key (A-Key) and operation key (O-Key) of an LACP-enable aggregation port cannot be modified.
- 4) The operation key (O-Key) which is contained in LACPDU of an LACP-enable aggregation port is the same as its peer.

5.1.3 Static Aggregation Group

1) Introduction to Static Aggregation

A static aggregation group is manually created. All its member ports are manually added and can be manually removed. Each static aggregation group must contain at least one port. When a static aggregation group contains only one port, you cannot remove the whole aggregation group unless you remove the port.

LACP is disabled on the member ports of static aggregation groups, and enabling LACP on such a port will not take effect.

2) Port status of Static Aggregation Group

A port in a static aggregation group is only in one state: on, which means the port in a static

aggregation group must transceive packets. There can be at most 8 ports in a static aggregation group.

5.1.4 Dynamic LACP Aggregation Group

1) Introduction to Dynamic LACP Aggregation Group

A dynamic LACP aggregation group is also manually created. All its member ports are manually added and can be manually removed. Each dynamic aggregation group must contain at least one port. When a dynamic aggregation group contains only one port, you cannot remove the whole aggregation group unless you remove the port.

LACP is enabled on the member ports of dynamic aggregation groups, and disabling LACP on such a port will not take effect.

2) Mode of Dynamic Aggregation Group

The mode of dynamic aggregation group can be active or passive. It is manually set by users. The dynamic aggregation group in active mode will actively send LACPDU; group in passive mode will only response LACPDUs passively. When interconnecting with another device, static mode can only interconnect with static mode; active mode can interconnect with both active and passive mode, but passive mode can only interconnect with active mode. The default mode is ACTIVE.

3) Port Status of Dynamic Aggregation Group

A port in a dynamic aggregation group can be in one of the three states: bundle (bndl), standby, and no-bundle (no-bndl). In dynamic aggregation group, only bundled ports can transceive LACP protocol packets; others cannot.

Note:

In an aggregation group, the bundled port with the minimum port number serves as the master port of the group, and other bundled ports serve as member ports of the group.

No-bundled ports are the ports which fail to form link aggregation with other ports in the dynamic aggregation.

There is a limit on the number of bundled ports in an aggregation group. Therefore, if the number of the member ports that can be set as bundled ports in an aggregation group exceeds the maximum number supported by the device, the system will negotiate with its peer end, to determine the states of the member ports according to the port IDs of the preferred device (that is, the device with smaller system ID). The following is the negotiation procedure:

- 1) Compare device IDs (system priority + system MAC address) between the two parties. First compare the two system priorities, then the two system MAC addresses if the system priorities are equal. The device with smaller device ID will be considered as the preferred one.
- 2) Compare port IDs (port priority + port number) on the preferred device. The comparison between two port IDs is as follows: First compare the two port priorities, then the two port numbers if the two port priorities are equal; the port with the smallest port ID is the bundled port and the left ports are standby ports.

4) Configure System Priority

LACP determines the bundled and standby states of the dynamic aggregation group members according to the priority of the port ID on the end with the preferred device ID.

The device ID consists of system priority and system MAC address, that is, device ID = system priority + system MAC address.

When two device IDs are compared, the system priorities are compared first, and the system MAC addresses are compared when the system priorities are the same. The device with smaller device ID will be considered as the preferred one.

Note:

Changing the system priority of a device may change the preferred device between the two parties, and may further change the states (bundled or standby) of the member ports of dynamic aggregation groups.

5) Configure Port Priority

LACP determines the bundled and standby states of the dynamic aggregation group members according to the port IDs on the device with the preferred device ID. When the number of members in an aggregation group exceeds the number of bundled ports supported by the device in each group, LACP determines the bundled and standby states of the ports according to the port IDs. The ports with superior port IDs will be set to bundled state and the ports with inferior port IDs will be set to standby state.

The port ID consists of port priority and port number, that is, port ID = port priority + port number. When two port IDs are compared, the port priorities are compared first, and the port numbers are compared if the port priorities are the same. The port with smaller port ID is considered as the preferred one.

5.2 Redundancy of Interconnected Device

LACP provides link redundancy mechanism to guarantee the redundancy conformity of the two interconnected devices and user can configure the redundant link which is realized by system and port priority. The steps are as following:

Step 1 Selection reference. The two devices know the LACP sys-id and system MAC address of each other through LACPDUs exchanges. The system priorities are compared first, and the system MAC addresses are compared when the system priorities are the same. The device with smaller device ID will be considered as the preferred one.

Step 2 Redundant link. The port priorities are compared first, and the port numbers are compared if the port priorities are the same. The port with smaller port ID is considered as the preferred one.

5.3 Load-balancing Policy

Load-balancing policy is specific physical link selection strategy when sending packets, which can be source MAC, destination MAC, source and destination MAC, source IP, destination IP, and source and destination IP. The default strategy is source MAC.

5.4 Configure Link Aggregation

5.4.1 Link Aggregation Configuration List

Configuration Task	Description	Detailed Configuration
--------------------	-------------	------------------------

Configure a Static Aggregation Group	Required	5.4.2
Configure a Dynamic LACP Aggregation Group	Required	5.4.3
Display and Maintain Link Aggregation Configuration	Optional	5.4.4

5.4.2 Configure a Static Aggregation Group

You can create a static aggregation group, or remove an existing static aggregation group (before that, all the member ports in the group are removed).

You can manually add/remove a port to/from a static aggregation group, and a port can only be manually added/removed to/from a static aggregation group.

Perform the configuration in global configuration mode.

Operation	Command	Remarks
Enter global configuration mode	system-view	
Create a static aggregation group	channel-group <i>channel-group-number</i>	<i>channel-group-number</i> ranges from 0 to 51.
Configure load-balancing policy	channel-group load-balance { dst-ip dst-mac src-dst-ip src-dst-mac src-ip src-mac }	
Enter interface configuration mode	interface ethernet <i>interface-num</i>	
Enter interface range configuration mode	interface range ethernet <i>interface-list</i>	
Add a port to the aggregation group	channel-group <i>channel-group-number</i> mode on	

Delete a port from an aggregation group	undo channel-group <i>channel-group-number</i>	
Back to global configuration mode	quit	
Delete a static aggregation group	undo channel-group <i>channel-group-number</i>	

5.4.3 Configure Dynamic LACP

You can manually add/remove a port to/from a dynamic aggregation group, and a port can only be manually added/removed to/from a dynamic aggregation group.

Operation	Command	Remarks
Enter global configuration mode	system-view	
Create a dynamic aggregation group	channel-group <i>channel-group-number</i>	<i>channel-group-number</i> ranges from 0 to 51
Configure load-balancing policy	channel-group load-balance { dst-ip dst-mac src-dst-ip src-dst-mac src-ip src-mac }	Src-mac by default
Configure system priority	lacp system-priority <i>priority</i>	32768 by default
Enter interface configuration mode	interface <i>thernet interface-num</i>	
Enter interface range configuration mode	interface range ethernet <i>interface-list</i>	
Add a port to the aggregation group	channel-group <i>channel-group-number</i> mode { active passive }	
Configure port priority	lacp port-priority <i>priority</i>	128 by default
Delete a port from an aggregation group	undo channel-group <i>channel-group-number</i>	

Back to global configuration mode	quit	
Delete a dynamic aggregation group	undo channel-group <i>channel-group-number</i>	

5.4.4 Display and Maintain LACP

After the above configuration, execute the display command in any mode to display the running status after the link aggregation configuration and verify your configuration.

Operation	Command	Remarks
Display system LACP ID	display lacp sys-id	System LACP-ID consists of 16-bit system priority and 48-bit system MAC.
Display port member info of the aggregation group	display lacp internal [<i>channel-group-number</i>]	
Display neighbor port info of the aggregation group	display lacp neighbor [<i>channel-group-number</i>]	
Display packet statistics of the aggregation group	display statistics channel-group [<i>channel-group-id</i>]	
Display packet statistics of the aggregation group by dynamic	display statistics dynamic channel-group	
Display utilization statistics of the aggregation group	display utilization channel-group	

Clear packet statistics of the aggregation group	clear channel-group [<i>channel-group-id</i>]	
--	--	--

Chapter 6 Port Isolation

6.1 PortIsolation Overview

To implement Layer 2 isolation, you can add different ports to different VLANs. However, this will waste the limited VLAN resource. With port isolation, the ports can be isolated within the same VLAN. Thus, you need only to add the ports to the isolation group to implement Layer 2 isolation. This provides you with more secure and flexible networking schemes.

On the current device:

- Currently, only one isolation group is supported on a device, which is created automatically by the system as isolation group. The user cannot remove the isolation group or create other isolation groups.
- The number of the ports an isolation group can contain is total port number-1. Because isolated ports are downlink ports. There should be at least one uplink port.

Note:

When a port in an aggregation group is configured as the member of isolation group, the other ports of the aggregation group will not be downlink ports.

6.2 Configure Port Isolation

6.2.1 Add/remove Isolated Ports

Add a port to port-isolation group. The isolated port members cannot communicate with each other, but can only communicate with un-isolated port.

Operation	Command	Remarks
Enter global configuration mode	system-view	
Enter interface range configuration mode	interface range <i>interface-list</i>	
Configure port isolation	port-isolation uplink { ethernet gpon } <i>interface-num</i>	
Delete uplink port	undo port-isolation [uplink { ethernet gpon } <i>interface-num</i>]	

6.2.2 Display Port Isolation Configuration

Operation	Command	Remarks
Display isolate-port configuration	display port-isolation [ethernet <i>interface-list</i>]	Display isolate-port configuration

Chapter 7 Storm-Control

7.1 Storm-Control Overview

When there is loop or malicious attacker in the network, there will be plenty of packets, which occupy the bandwidth and even affect the network. Storm-control will avoid too much packets appear in the network. Restrict the speed rate of port receiving broadcast/multicast/unknown unicast packets and unknown unicast packets received by all ports. By default, Broadcast storm control is Enable; Multicast storm control is Disable; Unicast storm control is Disable.

7.2 Configure Storm-Control

7.2.1 Configure Storm-Control

Operation	Command	Remarks
Enter global configuration mode	system-view	
Enter interface configuration mode	interface [range] { { ethernet <i>interface-list</i> } <i>interface-name</i> }	
Configure storm-controltype and rate	storm-control { broadcast multicast unicast } { disable pps <i>target-rate</i> }	
Delete port storm	undo storm-control { broadcast multicast unicast }	

7.2.2 Storm-Control Monitor and Maintenance

Operation	Command	Remarks
Display Storm-control	display storm-control interface [ethernet <i>interface-list</i>]]	

Chapter 8 VLAN

8.1 VLAN Overview

Virtual Local Area Network (VLAN) groups the devices of a LAN logically but not physically into segments to implement the virtual workgroups. IEEE issued the IEEE 802.1Q in 1999, which was intended to standardize VLAN implementation solutions.

Through VLAN technology, network managers can logically divide the physical LAN into different broadcast domains. Every VLAN contains a group of workstations with the same demands. The workstations of a VLAN do not have to belong to the same physical LAN segment.

With VLAN technology, the broadcast and unicast traffic within a VLAN will not be forwarded to other VLANs, therefore, it is very helpful in controlling network traffic, saving device investment, simplifying network management and improving security.

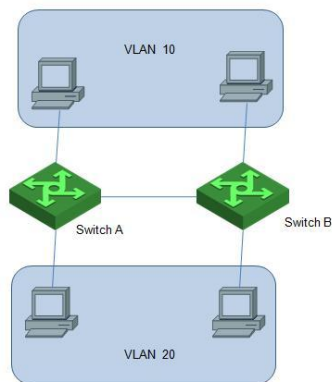

A VLAN can span across multiple GPONes, or even routers. This enables hosts in a VLAN to be dispersed in a looser way. That is, hosts in a VLAN can belong to different physical network segment.

Compared with the traditional Ethernet, VLAN enjoys the following advantages.

- 1) Broadcasts are confined to VLANs. This decreases bandwidth utilization and improves network performance.
- 2) Network security is improved. VLANs cannot communicate with each other directly. That is, a host in a VLAN cannot access resources in another VLAN directly, unless routers or Layer 3 GPONes are used.
- 3) Network configuration workload for the host is reduced. VLAN can be used to group specific hosts. When the physical position of a host changes within the range of the VLAN, you need not change its network configuration.

8.1.1 VLAN Principles

VLAN tags in the packets are necessary for the GPON to identify packets of different VLANs. The GPON works at Layer 2 (Layer 3 GPONes are not discussed in this chapter) and it can identify the data link layer encapsulation of the packet only, so you can add the VLAN tag field into only the data link layer encapsulation if necessary.

In 1999, IEEE issues the IEEE 802.1Q protocol to standardize VLAN implementation, defining the structure of VLAN-tagged packets.

IEEE 802.1Q protocol defines that a 4-byte VLAN tag is encapsulated after the destination MAC address and source MAC address to display the information about VLAN.

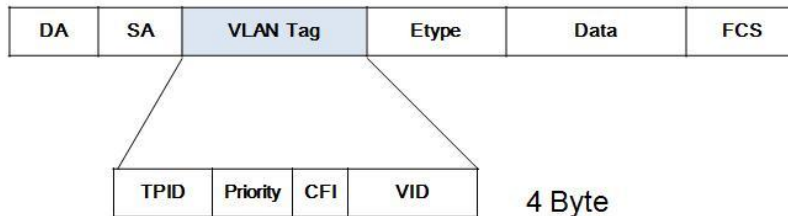

As shown in Figure 1-2, a VLAN tag contains four fields, including TPID (Tag Protocol Identifier), priority, CFI (Canonical Format Indicator), and VID (VLAN ID).

TPID is a 16-bit field, indicating that this data frame is VLAN-tagged. By default, it is 0x8100.

Priority is a 3-bit field, referring to 802.1p priority. Refer to section “QoS & QoS profile” for details.

CFI is a 1-bit field, indicating whether the MAC address is encapsulated in the standard format in different transmission media. This field is not described in detail in this chapter.

VID (VLAN ID) is a 12-bit field, indicating the ID of the VLAN to which this packet belongs. It is in the range of 0 to 4,095. Generally, 0 and 4,095 is not used, so the field is in the range of 1 to 4,094.

VLAN ID identifies the VLAN to which a packet belongs. When the GPON receives an un-VLAN-tagged packet, it will encapsulate a VLAN tag with the default VLAN ID of the inbound port for the packet, and the packet will be assigned to the default VLAN of the inbound port for transmission. For the details about setting the default VLAN of a port, refer to section “02-Port Configuration”

8.2 Configure 802.1Q VLAN

8.2.1 802.1Q VLAN Configuration List

Configuration Task	Description	Detailed Configuration
Create and Modify VLAN	Required	8.2.2
Delete Port Members from a VLAN	Optional	8.2.3
Delete VLAN	Optional	8.2.4
Configure Interface Default vlan ID	Optional	8.2.5
Configure Interface VLAN Mode	Optional	8.2.6
VLAN Attributes Based on Hybrid Interface	Optional	8.2.7
VLAN Attributes Based on Trunk Interface	Optional	8.2.8
Configure Port Priority	Optional	8.2.9
Configure Ingress Filtering	Optional	8.2.10
Configure Types of Interface acceptable-frame	Optional	8.2.11
Display VLANconfiguration	Optional	8.2.12

8.2.2 Create and Modify VLAN

GPON supports 4094 VLANs.

Perform following commands in privilege mode.

Operation	Command	Remarks
Enter global configuration mode	system-view	
Create a vlan and enter vlan configuration mode	vlan <i>vlan-list</i>	
Add port member to a vlan	port ethernet <i>interface-num</i>	
Configure vlan description	description <i>vlan-name</i>	By default, vlan description is empty.
Display the related information about VLAN	display vlan { <i>vlan-id</i> brief }	

Note : If the VLAN to be created exists, enter the VLAN mode directly. Otherwise, create the VLAN first, and then enter the VLAN mode.

Vlan-id allowed to configure is in the range of 1 to 4094. Vlan-list can be in the form of discrete number, a sequence number, or the combination of discrete and sequence number, discrete number of which is separate by comma, and sequence number of which is separate by subtraction sign, such as: 2, 5, 8, 10-20.

8.2.3 Delete Port Members from a VLAN

Perform following commands in privilege mode.

Operation	Command	Remarks
Enter global configuration mode	system-view	
Create a vlan and enter vlan configuration mode	vlan <i>vlan-list</i>	
Delete port member from VLAN	undo port { all ethernet <i>interface-num</i> }	
Display the related information	display vlan { <i>vlan-id</i> brief }	

about VLAN		
------------	--	--

8.2.4 Delete VLAN

Perform following commands in privilege mode.

Operation	Command	Remarks
Enter global configuration mode	system-view	
Delete VLAN	undo vlan { <i>vlan-list</i> all }	
Display the related information about VLAN	display vlan { <i>vlan-id</i> brief }	

8.2.1 Configure Interface Default VLAN ID

Perform following commands in privilege mode.

Operation	Command	Remarks
Enter global configuration mode	system-view	
Enter Interface configuration mode	interface ethernet <i>interface-num</i>	
Configure interface pvid	port default vlan <i>vlan-id</i>	
Configure interface default pvid	undo port default vlan	Vlan1 by default
Display interface detailed configurations	display interface ethernet <i>interface-num</i>	

Display interface brief configurations	display interface brief ethernet [<i>interface-num</i>]	
--	---	--

8.2.2 Configure Interface VLAN Mode

Interface VLAN mode can be divided into three types according to the different process modes the interface performs on tag label:

Access: the interface only belongs to one vlan, and it usually is used to connect the terminal device.

Trunk: the interface can be able to receive and forward multiple vlans. When the packet is forwarded, the default vlan packet will not carry the tag whereas the other vlan will carry the tag, and the tag is applied to the GPON interface.

Hybrid: the interface can be able to receive and forward multiple vlans, and it allows multiple vlans to carry the tag or not carry the tag.

Interface VLAN mode	Processing on receiving message		Processing on forwarding message
	Untag	Tag	
Access	Receive it	If the VLAN ID of the packet is	If the VLAN ID carried in a packet is the VLAN ID that the port allows to pass through, the VLAN tag will be striped and the packet will be forwarded.
Hybrid	and add a tag of pvid to it.	a VLAN that the port allows to pass through, the packet will	<ol style="list-style-type: none"> 1. If the VLAN ID carried in the packet is the UNTAG VLAN ID the port allows to pass through, the VLAN tag will be striped and the packet will be forwarded. 2. If the VLAN ID carried in the packet is the TAG VLAN ID the port allows to

		be accepted.	pass through, the VLAN tag will remain and the packet will be forwarded.
Trunk		Otherwise, the packet will be discarded.	<p>When the VLAN ID carried in a packet is the VLAN ID that the port allows to pass through::</p> <ol style="list-style-type: none"> 1. If the VLAN ID is not consistent with the port PVID, VLAN tag will be remained and the packet will be forwarded. 2. If the VLAN ID is consistent with the port PVID, VLAN tag will be stripped and the packet will be forwarded.

Configure interface vlan mode

Operation	Command	Remarks
Enter global configuration mode	system-view	
Enter Interface configuration mode	interface ethernet <i>interface-num</i>	
Configure interface vlan mode	port mode { access hybrid trunk }	Hybrid by default.

8.2.3 VLAN Attributes Based on Hybrid Interface

Operation	Command	Remarks
Enter global configuration mode	system-view	
Enter Interface configuration mode	interface ethernet <i>interface-num</i>	
Configure interface vlan mode	port mode hybrid	

Allow the specified vlan to pass through this hybrid port	port hybrid { tagged untagged } vlan { <i>vlan-list</i> all }	“tagged” means that the vlan packet carries tag; “untagged” means that the vlan packet does not carry tag;
Does not allow the specified vlan to pass this hybrid port	undo port hybrid vlan <i>vlan-list</i>	

8.2.4 VLAN Attributes Based on Trunk Interface

Operation	Command	Remarks
Enter global configuration mode	system-view	
Enter Interface configuration mode	interface ethernet <i>interface-num</i>	
Configure interface vlan mode	port mode trunk	
Allow the specified vlan to pass through this trunk port	port trunk allowed vlan { <i>vlan-list</i> all }	

Do not allow the specified vlan to pass through this trunk port	undo port trunk allowed vlan { <i>vlan-list</i> all }	
---	---	--

8.2.5 Configure Port Priority

If GPON receives a untagged packet, system will add a vlan tag to the packet in which the vid value in the tag is the PVID value and the priority value is the port priority value.

Operation	Command	Remarks
Enter global configuration mode	system-view	
Enter Interface configuration mode	interface ethernet <i>interface-num</i>	
Configure port priority	priority <i>value</i>	
Restore default priority	undo priority	0 by default
Display the port detailed configurations	display interface ethernet <i>interface-num</i>	
Display the port brief configurations	display interface brief ethernet [<i>interface-num</i>]	

8.2.6 Configure Ingress Filtering

By default, interface will check whether the receiving packet belongs to the vlan, if it does, the

interface will perform the forward processing. Otherwise, it will discard the packet. This process is called ingress filtering. GPON will enable this function by default and this function is allowed to be disabled.

Operation	Command	Remarks
Enter global configuration mode	system-view	
Enter Interface configuration mode	interface ethernet <i>interface-num</i>	
Configure ingress filtering	[undo] ingress filtering	Enabled by default
Display the configuration information	display ress [interface <i>interface-num</i>]	

8.2.7 Configure Types of Interface Acceptable-frame

By default, regardless of any type of packet (tag or untag) received by the GPON, it is allowed to change the port to receive only tag packets.

Operation	Command	Remarks
Enter global configuration mode	system-view	
Enter Interface configuration mode	interface ethernet <i>interface-num</i>	
Configure interface priority	ingress acceptable-frame { all tagged }	“all” means it can receive the tag packets and untag packets;

		“tagged” means it can only receive the tag packets.
Display the configuration information	display ingress [interface <i>interface-num</i>]	

8.2.8 Display VLAN configuration

Operation	Command	Remarks
Display VLAN configuration by vlanid	display vlan [<i>vlan-id</i>]	
Display VLAN configuration by brief	display vlan brief	
Display VLAN configuration by interface	display vlan interface [ethernet <i>interface-num</i>]	

8.3 Configure MAC-Based VLAN

8.3.1 MAC-Based VLAN Overview

As noted earlier, a single port in the campus network has multiple services, and each service belongs to different VLANs. So the flexible configuration of VLAN under the GPON port to identify different services has become a key issue of the campus network management.

In order to solve the above-mentioned problems, the MAC-based VLAN is proposed. MAC (Media Access Control) address is burnt on a Network Interface Card (NIC), also known as the hardware address. It's composed of 48 bits long (6 bytes), 16 hex digits.

MAC-based VLAN is another way to distinguish VLAN that tag of VLAN is added to packet according to the source MAC address. This is often in combination with security technologies (such as 802.1X) to achieve the purpose of the terminal's safety and flexible access.

8.3.2 Configure MAC-Based VLAN

Users should bind the terminal MAC address with VLAN via the command line, and the device will generate a corresponding MAC VLAN table.

The implementation of this approach is simple, only involved in access equipment. But in this way, it is necessary to manually configure the MAC VLAN of the terminal on terminal accessible ports. It was a big project.

Operation	Command	Remarks
Enter global configuration mode	system-view	
Configure static vlan-mac table	mac-vlan mac-address mac-address vlan [<i>priority</i>]	
Delete vlan-mac table	undo mac-vlan [mac-address <i>mac-address</i>]	
Display vlan-mac table	display vlan-mac-table [mac-address]	

8.4 Configure Protocol-Based VLAN

8.4.1 Protocol-Based VLAN Overview

Protocol-based VLAN: the packet distributes different VLAN ID according to the receiving

protocol types and encapsulation formats. "Protocol types + encapsulation formats" is also called model agreement. One protocol vlan can be able to bind multiple model agreements. Different model agreements can be distinguished by the vlan-protocol table index. Agreement profile is referenced to the port, and then you can modify the packet vlan according to the model agreements.

Untagged packet processing (no vlan tag):

1. If the packet protocol types and encapsulation formats are conform to the model agreements, it will be tagged with the protocol vlan-id.
2. If the packet protocol types and encapsulation formats are not conforming to the model agreements, it will be tagged with the port default VLAN ID.

Tagged packet processing (has vlan tag):

1. If the packet protocol types and encapsulation formats are conform to the model agreements, the outer vlan information will be modified to be the protocol vlan-id.
2. If the packet protocol types and encapsulation formats are not conform to the model agreements, the processing mode will be the same as the port-based vlan.

This feature is mainly applied to bind the service type with VLAN, providing convenient management and maintenance.

There are two types' configuration modes of protocol-based VLAN. Please choose the suitable one according to the equipment type.

8.4.2 Configure Protocol-Based VLAN

Operation	Command	Remarks
Enter global configuration mode	system-view	

Configure protocol profile	protocol-vlan profile <i>index</i> frame-type <i>eth-type</i>	
Delete protocol profile	undo protocol-vlan profile [<i>index</i>]	
Enter Interface configuration mode	interface ethernet <i>interface-num</i>	
Bind protocol-vlan profile	protocol-vlan profile <i>index</i> vlan <i>vlan-id</i> [priority <i>priority</i>]	
Undo bind protocol-vlan profile	undo protocol-vlan profile [<i>index</i>]	
Display protocol-vlan profile	display protocol-vlan profile [<i>index</i>]	
Display protocol-vlan profile bind	display protocol-vlan interface [ethernet <i>interface-num</i>]	

8.5 Configure IP-subnet VLAN

8.5.1 IP-subnet VLAN Overview

IP subnet-based vlan is divided according to packet source IP address and subnet mask. After device received packets from the interface, it will confirm the packets belonging to which VLAN and then automatically divide these packets to specified VLAN.

8.5.2 Configure IP-subnet VLAN

Operation	Command	Remarks
Enter global configuration mode	system-view	
Configure ip-subnet-vlan table	ip-subnet-vlan ipv4 <i>ip-address</i> mask <i>mask</i> vlan <i>vlanid</i> [priority <i>priority</i>]	
Delete ip-subnet-vlan table	undo ip-subnet-vlan [ipv4 <i>ip-address</i> mask <i>mask</i>]	
Enable the IP subnet-based VLAN	ip-subnet-vlan precede	
Disable the IP subnet-based VLAN	undo ip-subnet-vlan precede	
Display ip-subnet-vlan table	display ip-subnet-vlan [ipv4 <i>ip-address</i> mask <i>mask</i>]	

Chapter 9 QinQ

9.1 QinQ Overview

9.1.1 Understanding QinQ

In the VLAN tag field defined in IEEE 802.1Q, only 12 bits are used for VLAN IDs, so a GPON can support a maximum of 4,094 VLANs. In actual applications, however, a large number of VLANs are required to isolate users, especially in metropolitan area networks (MANs), and 4,094 VLANs are far from satisfying such requirements. shows the structure of 802.1Q-tagged and double-tagged Ethernet frames. The QinQ feature enables a device to support up to 4,094 x 4,094 VLANs to satisfy the requirement for the amount of VLANs in the MAN.

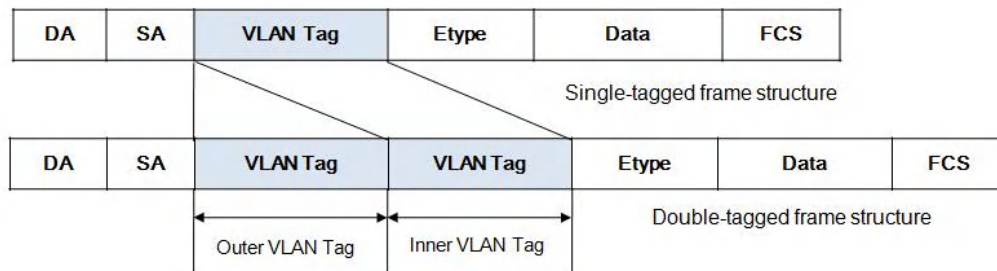

The port QinQ feature is a flexible, easy-to-implement Layer 2 VPN technique, which enables the access point to encapsulate an outer VLAN tag in Ethernet frames from customer networks (private networks), so that the Ethernet frames will travel across the service provider's backbone network (public network) with double VLAN tags. The inner VLAN tag is the customer network VLAN tag while the outer one is the VLAN tag assigned by the service

provider to the customer. In the public network, frames are forwarded based on the outer VLAN tag only, with the source MAC address learned as a MAC address table entry for the VLAN indicated by the outer tag, while the customer network VLAN tag is transmitted as part of the data in the frames.

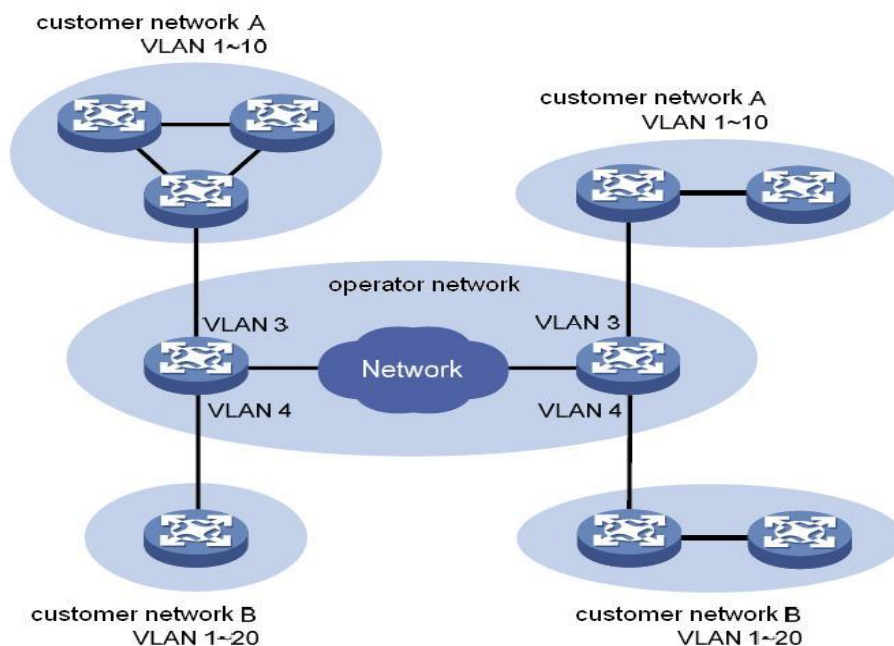

9.1.2 Implementations of QinQ

There are two types of QinQ implementations: basic QinQ and Flexible QinQ.

1) Basic QinQ

Basic QinQ is implemented through VLAN VPN.

With the VLAN VPN feature enabled on a port, when a frame arrives at the port, the GPON will tag it with the port's default VLAN tag, regardless of whether the frame is tagged or untagged.

If the received frame is already tagged, this frame becomes a double-tagged frame; if it is an untagged frame, it is tagged with the port's default VLAN tag.

2) Flexible QinQ

Flexible QinQ is a more flexible, VLAN-based implementation of QinQ. If Flexible QinQ on port is enabled, Flexible QinQ can:

- For ingress packet, different outer vlan tag can be added according to different inner VLAN ID
- For ingress packet, new VLAN tag can take the place of some specific VLAN Tag
- For ingress packet, some VLAN can be transparent transmit.

For QinQ-enabled port, there are different handlings for different port type:

Uplink port: The Tag judgment on uplink port is based on the consistency between packet VID and configured global outer-tpid.

Custom port: The Tag judgment on customer port is based on the consistency between packet VID and inner-tpid. The default inner-tpid is 0x8100

9.1.3 Modification of TPID Value of QinQ Frames

A VLAN tag uses the tag protocol identifier (TPID) field to identify the protocol type of the tag. The value of this field, as defined in IEEE 802.1Q, is 0x8100. The device can identify whether there is corresponded VLAN Tag according to TPID. If configured TPID is the same as the corresponded field, packet is regarded as with VLAN Tag.

The systems of different vendors may set the TPID of the outer VLAN tag of QinQ frames to different values. For compatibility with these systems, the S3750-48 series GPONes allow you to modify the TPID value so that the QinQ frames, when sent to the public network, carry the

TPID value identical to the value of a particular vendor to allow interoperability with the devices of that vendor.

The TPID in an Ethernet frame has the same position with the protocol type field in a frame without a VLAN tag. To avoid problems in packet forwarding and handling in the network, you cannot set the TPID value to any of the values in the table below.

Protocol type	Value
ARP	0x0806
PUP	0x0200
RARP	0x8035
IP	0x0800
IPv6	0x86DD
PPPoE	0x8863/0x8864
MPLS	0x8847/0x8848
IPX/SPX	0x8137
IS-IS	0x8000
LACP	0x8809
802.1x	0x888E
GnLink	0x0765
GSTP	0X5524

9.2 Configure QinQ

9.2.1 QinQ Configuration Task List

Configuration Task	Description	Detailed Configuration
Configure BASIC QinQ	Required	9.2.2
Configure Flexible QinQ	Required	9.2.3
Display QinQ configuration	Optional	9.2.4

9.2.1 Configure BASIC QinQ

Perform following commands in privilege mode.

Operation	Command	Remarks
Enter global configuration mode	system-view	
Enter interface configuration mode	interface ethernet <i>interface-num</i>	
Enable basic QinQ	qinq	
Disable basic QinQ	undo qinq	

9.2.2 Configure Flexible QinQ

Perform following commands in privilege mode.

Operation	Command	Remarks
Enter global configuration mode	system-view	
Enter interface configuration mode	interface ethernet <i>interface-num</i>	
Modify outer TPID	qinq { inner-tpid outer-tpid } <i>tpid-value</i>	
Add different outer VLAN Tag for different inner VID	flexible-vlan insert <i>start-vlan-id end-vlan-id service-vlan-idpriority</i>	

Configure vlan-swap	flexible-vlan swap <i>start-vlan-id end-vlan-id target-vlan-idpriority</i>	
Configure packet belonged to specified vlan range need not to add double VLAN Tag	flexible-vlan pass-through <i>start-vlan-id end-vlan-id</i>	

9.2.3 Display QinQ configuration

Operation	Command	Remarks
Display qinq configuration	display flexible-vlan interface [ethernet <i>interface-list</i>]	

Chapter 10 MAC Address Table

10.1 MAC Address Table Overview

The system maintains a MAC address table for forwarding packets. The entries in this table contain the device MAC addresses, VLAN IDs, and GPON port numbers. When a packet enters the GPON, the GPON looks up the MAC address table based on the destination MAC address of the packet and the VLAN ID of the packet. If the packet is found, the GPON sends the packets to the specified ports. Otherwise, GPON will broadcast the packets in this VLAN.

The system can be able to learn MAC address table. If the source MAC address of a received packet does not exist in the MAC address table, the system will add the source MAC address, VLAN ID, and port number of the received packet as a new entry to the MAC address table.

You can manually configure MAC address entries. The administrator can configure the MAC address table based on the actual network condition, that is, the administrator can add or modify static entries, permanent entries, blackhole entries, dynamic entries.

System provides MAC address aging function. If a device does not send any packets for a certain period of time, the system deletes the MAC address entries associated with the device.

MAC address aging only takes effect on the learned MAC address or the MAC address entries which can be aged (the dynamic MAC address entries).

10.2 Configure MAC Address Table

10.2.1 MAC Address Table Configuration Task List

Configuration Task	Description	Detailed Configuration
Configure the Aging Time	Optional	10.2.2
Add MAC Address Table by Manual	Optional	10.2.3
Display MAC Address Table	Optional	10.2.4
Enable/Disable MAC Learning	Optional	10.2.5
Quantity Limitation on MAC Address Learning Table	Optional	10.2.6

10.2.2 Configure the Aging Time

Operation	Command	Remarks
Enter global configuration mode	system-view	
Configure the aging time of MAC address	mac-address-table age-time { agetime disable }	<i>disable</i> means mac address will not be aged
Configure the default aging time of MAC address	undo mac-address-table age-time	300s by default
Display the aging time of MAC address	display mac-address-table age-time	
Display the aging time of MAC address	display mac-address-table age-time	

10.2.3 Add MAC Address Table by Manual

Operation	Command	Remarks
Enter global configuration mode	system-view	
Configure the static permanent dynamic mac-address	mac-address-table { static permanent dynamic } mac-address interface ethernet interface-num vlan vlan-id	

Configure the blackholemac-address	mac-address-table blackhole <i>mac-address</i> vlan <i>vlan-id</i>	
Delete the static permanent dynamicmac-address	undo mac-address-table [dynamic permanent static] <i>mac-address</i> interface ethernet <i>interface-num</i> vlan <i>vlan-id</i>	
Delete the blackholemac-address	undo mac-address-table [blackhole dynamic permanent static] <i>mac-address</i> vlan <i>vlan-id</i>	
Delete the static permanent dynamicmac-address by port	undo mac-address-table [static permanent dynamic] interface ethernet <i>interface-num</i>	
Delete the blackholemac-address by port	undo mac-address-table [blackhole dynamic permanent static] vlan <i>vlan-id</i>	
Delete all mac-address	undo mac-address-table	

10.2.4 Display MAC Address Table

Operation	Command	Remarks
Display all MAC address	display mac-address-table	
Display CPU MAC address	display mac-address-table cpu	
Display MAC address by mac	display mac-address-table <i>mac-address</i> [vlan <i>vlan-id</i>]	
Display MAC address by type	display mac-address-table { static	

	dynamic permanent blackhole } [vlan vlan-id]	
Display MAC address by port	display mac-address-table { static dynamic permanent blackhole } interface ethernet interface-num [vlan vlan-id]	
Display MAC address by vlan	display mac-address-table vlan vlan-id	

10.2.5 Enable/Disable MAC Learning

You can configure whether the device learns MAC addresses dynamically or not.

If MAC address learning is disabled under global configuration mode, all ports cannot learn MAC address; If you want to disable mac address learning on some ports, just enable MAC address learning under global configuration mode and disable MAC address learning on the port will be OK.

Operation	Command	Remarks
Enter global configuration mode	system-view	
Enable global mac learning	mac-address-table learning	
Disable global mac learning	undo mac-address-table learning	
Enter interface configuration mode	interface { { ethernet interface-num } interface-name }	
Enable mac learning	mac-address-table learning	

Disable mac learning	undo mac-address-table learning	
Display mac learning	display mac-address learning [interface ethernet [<i>interface-num</i>]]	

10.2.6 Quantity Limitation on MAC Address Learning Table

Under port configuration mode, you can configure the maximum number of learned MAC addresses on a port. By default, the number of MAC addresses learning table are unlimited.

Operation	Command	Remarks
Enter global configuration mode	system-view	
Enter vlan configuration mode	vlan <i>vlan-id</i>	
Configure max-mac-count	mac-address-table max-mac-count <i>max-mac-count</i>	
Configure the default max-mac-count	undo mac-address-table max-mac-count	
Enter interface configuration mode	interface { { ethernet <i>interface-num</i> } <i>interface-name</i> }	
Configure max-mac-count	mac-address-table max-mac-count <i>max-mac-count</i>	
Configure the default max-mac-count	undo mac-address-table max-mac-count	
Display the max-mac-count	display mac-address max-mac-count { interface ethernet [<i>interface-num</i>] vlan <i>vlan-id</i> }	

Chapter 11 STP

11.1 STP Overview

Spanning Tree Protocol (STP) is applied in loop network to block some undesirable redundant paths with certain algorithms and prune the network into a loop-free tree, thereby avoiding the proliferation and infinite cycling of the packet in the loop network.

11.1.1 Protocol Packets of Spanning-Tree

STP uses bridge protocol data units (BPDUs), also known as configuration messages, as its protocol packets.

STP identifies the network topology by transmitting BPDUs between STP-compliant network devices. BPDUs contain sufficient information for the network devices to complete the spanning tree calculation.

In STP, BPDUs come in two types:

Configuration BPDUs, used for calculating spanning trees and Maintain the spanning tree topology.

Topology change notification (TCN) BPDUs, used for notifying concerned devices of network topology changes, if any.

11.1.2 Basic Concepts in Spanning-Tree

Root Bridge

A tree network must have a root; hence the concept of “root bridge” has been introduced in STP.

There is one and only one root bridge in the entire network, and the root bridge can change alone with changes of the network topology. Therefore, the root bridge is not fixed.

Upon network convergence, the root bridge generates and sends out configuration BPDUs at a certain interval, and other devices just forward the BPDUs. This mechanism ensures topological stability.

Root Port

On a non-root bridge device, the root port is the port nearest to the root bridge. The root port is responsible for communication with the root bridge. A non-root-bridge device has one and only one root port. The root bridge has no root port.

Designated Bridge

For a device, Designated Bridge is the device directly connected with this device and responsible for forwarding BPDUs; For a LAN, Designated Bridge is the device responsible for forwarding BPDUs to this LAN segment.

Designated Port

For a device, Designated Port is the port through which the designated bridge forwards BPDUs to this device; For a LAN, Designated Port is the port through which the designated bridge forwards BPDUs to this LAN segment.

Path cost

Path cost is a reference value used for link selection in STP. By calculating the path cost, STP

selects relatively “robust” links and blocks redundant links, and finally prunes the network into loop-free tree structure.

11.1.3 Spanning-Tree Interface States

Each Layer 2 interface on a GPON using spanning tree exists in one of these states:

Disabled

The interface is not participating in spanning tree because of a shutdown port, no link on the port, or no spanning-tree instance running on the port.

Blocking

The interface does not participate in frame forwarding.

Listening

The first transitional state after the blocking state when the spanning tree determines that the interface should participate in frame forwarding.

Learning

The interface prepares to participate in frame forwarding.

Forwarding

The interface forwards frames.

An interface moves through these states:

- From initialization to blocking
- From blocking to listening or to disabled
- From listening to learning or to disabled
- From learning to forwarding or to disabled

- From forwarding to disabled

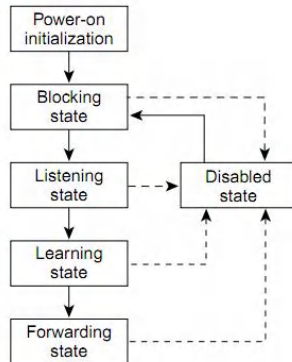

When you power up the GPON, spanning tree is enabled by default, and every interface in the GPON, VLAN, or network goes through the blocking state and the transitory states of listening and learning. Spanning tree stabilizes each interface at the forwarding or blocking state.

When the spanning-tree algorithm places a Layer 2 interface in the forwarding state, this process occurs:

- 1)The interface is in the listening state while spanning tree waits for protocol information to transition the interface to the blocking state.
- 2)While spanning tree waits the forward-delay timer to expire, it moves the interface to the learning state and resets the forward-delay timer.
- 3)In the learning state, the interface continues to block frame forwarding as the GPON learns end-station location information for the forwarding database.
- 4)When the forward-delay timer expires, spanning tree moves the interface to the forwarding state, where both learning and frame forwarding are enabled.

11.2 How Spanning-Tree Works

Spanning-Tree identifies the network topology by transmitting configuration BPDUs between network devices. Configuration BPDUs contain sufficient information for network devices to complete the spanning tree calculation. Important fields in a configuration BPDU include:

Root bridge ID: consisting of root bridge priority and MAC address.

Root path cost: the cost of the shortest path to the root bridge.

Designated bridge ID: designated bridge priority plus MAC address.

Designated port ID: designated port priority plus port name.

Message age: age of the configuration BPDU while it propagates in the network.

Max age: maximum age of the configuration BPDU maintained in the device.

Hello time: configuration BPDU interval.

Forward delay: forward delay of the port.

1) Specific calculation process of the STP algorithm

- Initial state

Upon initialization of a device, each port generates a BPDU with itself as the root bridge, in which the root path cost is 0, designated bridge ID is the device ID, and the designated port is the local port.

- Selection of the optimum configuration BPDU

Each device sends out its configuration BPDU and receives configuration BPDUs from other devices.

The process of selecting the optimum configuration BPDU is as follows:

Step	Description
1	<p>Upon receiving a configuration BPDU on a port, the device performs the following processing:</p> <p>If the received configuration BPDU has a lower priority than that of the configuration BPDU generated by the port, the device will discard the received configuration BPDU without doing any processing on the configuration BPDU of this port.</p> <p>If the received configuration BPDU has a higher priority than that of the configuration BPDU generated by the port, the device will replace the content of the configuration BPDU generated by the port with the content of the received configuration BPDU.</p>
2	The device compares the configuration BPDUs of all the ports and chooses the optimum configuration BPDU.

- Selection of the root bridge

At network initialization, each STP-compliant device on the network assumes itself to be the root bridge, with the root bridge ID being its own device ID. By exchanging configuration BPDUs, the devices compare one another's root bridge ID. The device with the smallest root bridge ID is elected as the root bridge.

- Selection of the root port and designated ports

The process of selecting the root port and designated ports is as follows:

Selection of the root port and designated ports

Step	Description
1	A non-root-ridge device regards the port on which it received the optimum configuration BPDU as the root port.

2	<p>Based on the configuration BPDU and the path cost of the root port, the device calculates a designated port configuration BPDU for each of the rest ports.</p> <ul style="list-style-type: none"> ● The root bridge ID is replaced with that of the configuration BPDU of the root port. ● The root path cost is replaced with that of the configuration BPDU of the root port plus the path cost corresponding to the root port. ● The designated bridge ID is replaced with the ID of this device. ● The designated port ID is replaced with the ID of this port.
3	<p>The device compares the calculated configuration BPDU with the configuration BPDU on the port of which the port role is to be defined, and does different things according to the comparison result:</p> <ul style="list-style-type: none"> ● If the calculated configuration BPDU is superior, the device will consider this port as the designated port, and the configuration BPDU on the port will be replaced with the calculated configuration BPDU, which will be sent out periodically. ● If the configuration BPDU on the port is superior, the device will block this port without updating its configuration BPDU, so that the port will only receive BPDUs, but not send any, and will not forward data.

Once the root bridge, the root port on each non-root bridge and designated ports have been unsuccessfully elected, the entire tree-shaped topology has been constructed.

2) The BPDU forwarding mechanism in spanning-tree

Upon network initiation, every GPON regards itself as the root bridge, generates configuration BPDUs with itself as the root, and sends the configuration BPDUs at a regular interval of hello time.

- If it is the root port that received the configuration BPDU and the received configuration

BPDU is superior to the configuration BPDU of the port, the device will increase message age carried in the configuration BPDU by a certain rule and start a timer to time the configuration BPDU while it sends out this configuration BPDU through the designated port.

- If the configuration BPDU received on the designated port has a lower priority than the configuration BPDU of the local port, the port will immediately send out its better configuration BPDU in response.
- If a path becomes faulty, the root port on this path will no longer receive new configuration BPDUs and the old configuration BPDUs will be discarded due to timeout. In this case, the device will generate a configuration BPDU with itself as the root and sends out the BPDU. This triggers a new spanning tree calculation process so that a new path is established to restore the network connectivity.

However, the newly calculated configuration BPDU will not be propagated throughout the network immediately, so the old root ports and designated ports that have not detected the topology change continue forwarding data along the old path. If the new root port and designated port begin to forward data as soon as they are elected, a temporary loop may occur.

3) STP timers

STP calculations need three important timing parameters: forward delay, hello time, and max age.

- Forward delay is the delay time for device state transition. A path failure will cause re-calculation of the spanning tree, and the spanning tree structure will change

accordingly. However, the new configuration BPDU as the calculation result cannot be propagated throughout the network immediately. If the newly elected root port and designated ports start to forward data right away, a temporary loop is likely to occur. For this reason, as a mechanism for state transition in STP, a newly elected root port or designated port requires twice the forward delay time before transitioning to the forwarding state, when the new configuration BPDU has been propagated throughout the network.

- Hello time is the time interval at which a device sends hello packets to the surrounding devices to ensure that the paths are fault-free.
- Max age is a parameter used to determine whether a configuration BPDU held by the device has expired. A configuration BPDU beyond the max age will be discarded.

11.3 Implement RSTP on Ethernet GPON

The Ethernet GPON implements the Rapid Spanning Tree Protocol (RSTP), i.e., the enhancement of STP. The Forward Delay for the root ports and designated ports to enter forwarding state is greatly reduced in certain conditions, thereby shortening the time period for stabilizing the network topology.

To achieve the rapid transition of the root port state, the following requirement should be met: The old root port on this GPON has stopped data forwarding and the designated port in the upstream has begun forwarding data.

The conditions for rapid state transition of the designated port are:

- The port is an Edge port that does not connect with any GPON directly or indirectly. If the designated port is an edge port, it can GPON to forwarding state directly without immediately forwarding data.
- The port is connected with the point-to-point link, that is, it is the master port in aggregation ports or full duplex port. It is feasible to configure a point-to-point connection. However, errors may occur and therefore this configuration is not recommended. If the designated port is connected with the point-to-point link, it can enter the forwarding state right after handshaking with the downstream GPON and receiving the response.

The GPON that uses RSTP is compatible with the one using STP. Both protocol packets can be identified by the GPON running RSTP and used in spanning tree calculation.

11.4 Configure RSTP

11.4.1 RSTP Configuration Task List

Configuration Task	Description	Detailed Configuration
Enable STP and Configure the working mode	Required	11.4.2
Configure STP bridge priority	Optional	11.4.3
Configure Time Parameter	Optional	11.4.4
Configure STP Path Cost	Optional	11.4.5
Configure STP Port Priority	Optional	11.4.6
Configure STP mcheck	Optional	11.4.7
Configure STP point-to-point mode	Optional	11.4.8
Configure STP portfast	Optional	11.4.9

Configure STP transit limit	Optional	11.4.10
RSTP Monitor and Maintenance	Optional	11.4.11

11.4.2 Enable RSTP and Configure the Working Mode

After enabling STP globally, all ports will be defaulted to join the STP topology calculating by default. If some port is not allowed to take part in the STP calculation, administrator can use `undo stp` command in interface configuration mode to disable STP on this port.

Operation	Command	Remarks
Enter global configuration mode	system-view	
Enable STP globally	stp	
Select STP mode	stp mode rstp	
Enter interface configuration mode	interface ethernet <i>interface-num</i>	
Enable/disable STP on port	[undo] stp	

Note:

When enable STP globally, the system is working under RSTP mode.

11.4.3 Configure STP Bridge Priority

The priority of bridge determines this GPON can be root or not. If this GPON is needed to be the root, the priority can be configured inferior.

By default, the GPON bridge priority is 32768.

Operation	Command	Remarks
Enter global configuration mode	system-view	
Configure STP priority	stp priority <i>bridge-priority</i>	

11.4.4 Configure Time Parameter

There are three time parameters: Forward Delay, Hello Time and Max Age.

User can configure these three parameters for RSTP calculation.

Operation	Command	Remarks
Enter global configuration mode	system-view	
Configure Hello-packet sending interval	stp hello-time <i>seconds</i>	
Configure STP forward-delay	stp forward-time <i>seconds</i>	
Configure STP max-age	stp max-age <i>seconds</i>	

Note:

Too long Hello Time may cause link failure thought by network bridge for losing packets of the link to restart accounting STP; too smaller Hello Time may cause network bridge frequently to send configuration packet to strengthen the load of network and CPU. Hello Time ranges from 1 to 10 seconds. It is suggested to use the default time of 2 seconds. $\text{Hello Time} \leq \text{Forward Delay} - 2$.

If Forward Delay is configured too small, temporary redundancy will be caused; if Forward Delay is configured too large, network will not be restored linking for a long time. Forward Delay ranges from 4 to 30 seconds. The default forward delay time, 15 seconds is suggested to use. $\text{Forward Delay} \geq \text{Hello Time} + 2$.

Max Age is used to configure the longest aging interval of STP. Lose packet when over-timing. The STP will be frequently accounts and take crowded network to be link fault, if the value is too small. If the value is too large, the link fault cannot be known timely. Max Age is determined by diameter of network, and the default time of 20 seconds is suggested. $2 * (\text{Hello Time} + 1) \leq$

Max Age $\leq 2 * (\text{ForwardDelay} - 1)$ When enable STP globally, the system is working under RSTP mode.

11.4.5 Configure STP Path Cost

Configure interface STP path cost and choose the path with the smallest path cost to be the effective path.

The path cost is related to the link speed rate. The larger the speed rate is, the less the cost is.

STP can auto-detect the link speed rate of current interface and converse it to be the cost.

Configure port path cost will make STP re-calculating. The value of the path cost is 1-65535. It is suggested using the default vaule, which makes the STP to calculate the current port cost by itself. By default, the path cost is determined by the current port speed.

When the port is 10M, the default cost is 200,000; when the port is 100M, the default cost is 20,000; 1000M, 2,000.

Operation	Command	Remarks
Enter global configuration mode	system-view	
Enter interface configuration mode	interface ethernet <i>interface-num</i>	
Configure STP path cost	stp cost <i>path-cost</i>	

11.4.6 Configure STP Port Priority

Specify specified port in STP by Configure port priority. Generally, the smaller the value is, the superior the priority is, and the port will be more possible to be included in STP. If the priorities are the same, the port number is considered.

The smaller the value is, the superior the priority is, and the port is easier to be the root

interface. Change the port priority may cause the re-calculating of the STP. The port priority ranges from 0 to 255. The default port priority is 128.

Operation	Command	Remarks
Enter global configuration mode	system-view	
Enter interface configuration mode	interface ethernet <i>interface-num</i>	
Configure STP port priority	stp port-priority <i>port-priority</i>	

11.4.7 Configure STP Mcheck

GPON working under RSTP mode can be connected to GPON with STP. But when the neighbor is working under RSTP, the two connected ports are still work under STP mode. Mcheck is for force port sending RSTP packet to make sure the two neighbor ports can be working under RSTP. If yes, the working mode will turn to be RSTP.

Operation	Command	Remarks
Enter global configuration mode	system-view	
Enter interface configuration mode	interface ethernet <i>interface-num</i>	
Configure STP mcheck	stp mcheck	

11.4.8 Configure STP Point-to-Point Mode

In rstp, the requirement of interface quickly in transmission status is that the interface must be point to point link not media sharing link. It can be specified interface link mode manually and can also judge it by network bridge.

Operation	Command	Remarks
Enter global configuration mode	system-view	

Enter interface configuration mode	interface ethernet <i>interface-num</i>	
Configure GPON auto-check the point-to-point	stp point-to-point auto	
Configure STP point-to-point mode forcetrue	stp point-to-point forcetrue	
Configure STP point-to-point mode forcefalse	stp point-to-point forcefalse	

11.4.9 Configure STP Portfast

Edge port is the port connecting to the host which can be in transmission status in very short time after linkup, but once the port receiving STP packet, it will shift to be non-edge port.

Operation	Command	Remarks
Enter global configuration mode	system-view	
Enter interface configuration mode	interface ethernet <i>interface-num</i>	
Configure STP portfast	stp portfast	

11.4.10 Configure STP Transit Limit

Restrict STP occupying bandwidth by restricting the speed of sending BPDU packet. The speed is determined by the number of BPDU sent in each hello time.

By default, port will send 3 BPDU packets in every Hello time interval.

Operation	Command	Remarks
Enter global configuration mode	system-view	
Enter interface configuration mode	interface ethernet <i>interface-num</i>	
Configure STP transit limit	stp transit-limit <i>transit-limit</i>	

11.4.11 RSTP Monitor and Maintenance

After finishing above configuration, user can check the configurations by command below.

Operation	Command	Remarks
Display STP interface	display stp interface [brief [ethernet <i>interface-num</i>]]	

Chapter 12 MSTP

12.1 MSTP Overview

The multiple spanning tree protocol (MSTP) overcomes the shortcomings of STP and RSTP. In addition to support for rapid network convergence, it also allows data flows of different VLANs to be forwarded along their own paths, thus providing a better load sharing mechanism for redundant links. For description about VLANs, refer to VLAN.

12.2 Configure MSTP

12.2.1 Enable MSTP and Configure the Working Mode

After the tree starts to give birth to a global default for all ports will participate in the spanning tree topology is calculated, if an administrator wants some of the port does not participate in the calculation of the production tree, or go to the specified port configuration mode, use the `undo stp` to disable the port Spanning Tree function.

Operation	Command	Remarks
Enter global configuration mode	system-view	
Choice STP mode	stp mode mstp	
Enable STP	stp	
Enter port configuration mode	interface ethernet <i>interface-num</i>	
Enable(disable) port STP	[undo] stp	

12.2.2 Configure MSTP Timer Parameter Values

MSTP timers include: forwarding delay, contracting cycle hello time, maximum aging time, and the maximum hops. Users can configure these three parameters on the GPON for MSTP spanning tree.

Operation	Command	Remarks
Enter global configuration mode	system-view	
Configure bridge forward delay	stp mst forward-time <i>forward-time</i>	
Configure bridge hello time	stp mst hello-time <i>hello-time</i>	
Configure bridge max aging time	stp mst max-age <i>max-age</i>	
Configure bridge max hops	stp mst max-hops <i>max-hops</i>	

Notes:

- The Hello Time value is too long will lead to packet loss due to leaving the bridge that links the link failure, began to re-calculate the spanning tree; too short can cause the bridge Hello Time value configured to send messages frequently to increase the network and CPU burden. Hello Time value range is 1 to 10 seconds, recommended default value of 2 seconds. Hello Time must be less than equal to the Forward Delay 2.
- If the Forward Delay configuration is too small, may introduce temporary redundant paths; if the Forward Delay configuration is too large, the network may not be a long time to restore connectivity. Forward Delay value range is 4 to 30 seconds, it is recommended to use the default value of 15 seconds. Forward Delay time must be greater than equal to the Hello Time + 2.
- Max Age is used to set the MSTP protocol packet aging longest interval, if the timeout, it

discards the packet. If this value is too small, spanning tree will be more frequent, there may be network congestion mistaken link failure; If this value is too large, is not conducive to timely detection of link failures. Max Age of the range is 6 to 40 seconds. Max Age time value and the exchange of the network diameter. Recommended default value of 20 seconds. Max Age time must be greater than equal to $2 * (\text{Hello Time} + 1)$, less than or equal $2 * (\text{Forward Delay}-1)$.

12.2.3 Configure MSTP Identifier

MSTP configuration identifiers include: MSTP configuration name, MSTP revision level, and the MSTP instance and VLAN mapping, MSTP will have the same configuration identifier and the bridge connected to each other logically be treated as a virtual bridge.

Operation	Command	Remarks
Enter global configuration mode	system-view	
Configure MSTP identifier name	stp mst name <i>name</i>	
Configure MSTP identifiers revision	stp mst revision <i>revision-level</i>	
Configure MSTP instance configuration and VLAN identifier mapping	stp mst instance <i>instance-num</i> vlan <i>vlan-list</i>	

12.2.4 Configure MSTP Bridge Priority

In MSTP, the bridge priority is based on the parameters of MSTI, the bridge priority together with port priority and port path cost determines the topology of each spanning tree instance, constitute the basis for link load balancing.

GPON bridge priority determines the size of this GPON is able to be selected as the spanning tree root bridge. By Configure the bridge priority of the smaller, you can specify a GPON to

become the spanning tree root bridge purposes.

By default, the GPON bridge priority is 32768.

Operation	Command	Remarks
Enter global configuration mode	system-view	
Configure MSTP instance priority	stp mst instance <i>instance-num</i> priority <i>priority</i>	

12.2.5 ConfiConfigure Root Port Protection

As the maintenance of configuration errors or malicious network attacks, network valid root bridge may receive a higher priority configuration information, so the root bridge will lose the current status of the root bridge, causing changes in network topology errors. Assuming the original traffic is forwarded through the high-speed links, this is not legally change will lead to the original high-speed links are to low-speed traffic links, resulting in network congestion. Root protection function to prevent this from happening.

Root-protection function of the port, the port can only be kept for a specified port. Once this port received a high priority on the configuration information, status of the ports will be set to the Discarding state, not forwarding packets (equivalent to the link connected to this port is disconnected). When a long enough period of time does not receive better configuration message, the port will revert to the original state.

In MSTP, this function works for all instances.

Operation	Command	Remarks
Enter global configuration mode	system-view	
Enter port configuration mode	interface ethernet <i>interface-num</i>	
Configure the root port protection	stp mst root-guard	

12.2.6 Configure Digest Snooping Port

When a GPON port uses a proprietary spanning tree with Cisco and other GPON is connected, these manufacturers' GPONs configured with the proprietary spanning tree protocol, even if the same MST region configuration, the GPON can't be achieved between the MSTP domain interoperability. Digest snooping feature such a situation. With the use of proprietary spanning tree protocol of the manufacturer's GPONs connected to the port on the digest snooping feature, when receiving the manufacturer's GPONs over to send a BPDU, the GPON that is from the same packet in an MST region, while the configuration summary record; when BPDU packets sent to these manufacturer's GPONs, the GPON configuration summary to supplement it. This GPON is realized and the manufacturer's GPONs in the MSTP region exchange.

Operation	Command	Remarks
Enter global configuration mode	system-view	
Enter port configuration mode	interface ethernet <i>interface-num</i>	
Configure digest snooping port	stp mst config-digest-snooping	

12.2.7 Configure Port mCheck Function

In order to flexibly control MSTP, you can open the DISABLE INSTANCE features, disable instance STP mode operating results with the implementation of no spanning-tree similar to the instance of the VLAN mapping of all connections on port forwarding state.

Operation	Command	Remarks
Enter global configuration mode	system-view	
Enter port configuration mode	interface ethernet <i>interface-num</i>	
Configuration port mcheck function	stp mcheck	

Note:

mcheck function is a prerequisite for the port must send BPDU packets, so only works on the

specified port.

12.2.8 Configure MSTP Instance Is Enabled

In order to flexibly control MSTP, you can open the DISABLE INSTANCE features, disable instance STP mode operating results with the implementation of no spanning-tree similar to the instance of the VLAN mapping of all connections on port forwarding state.

Operation	Command	Remarks
Enter global configuration mode	system-view	
Disable MSTP instance	stp mst disable instance <i>instance-number</i>	
Enable MSTP instances	undo stp mst disable instance <i>instance-number</i>	

12.2.9 Display and Maintain MSTP

After completing the above configuration, can use the following command to view configuration. RSTP.

Operation	Command	Remarks
MSTP configuration information display identifier	display stp mst config-id	
Display spanning tree instance and port configuration information	display stp mst instance [brief [<i>instance-list</i>]]	

Chapter 13 Remote-loop-detect

13.1 Remote-loop-detect Overview

The device is connected with the client. If there is a loop in the client network, which will affect the entire network. Remote-loop-detect is to solve this problem. After the Remote-loop-detect is enabled on the GPON port, the GPON periodically sends a detection message. If the client network has a loop, the GPON receives the detection message from the GPON. In this case, the GPON considers that the client network exists loop, and the port connected to the client port according to the treatment strategy placed discarding or shutdown.

Some people may ask, the spanning tree can also be remote loop detection, why need Remote-loop-detect? This is because if the client network also has equipment to open spanning tree, the client network topology change easily affects the network of the room. The general networking is to connect the client port which does not open the spanning tree, with remote-loop-detect alternative.

13.2 Configure Remote-loop-detect

13.2.1 Enable Remote-loop-detect

Operation	Command	Remarks
Enter the global configuration mode.	system-view	

Enable remote-loop-detect	stp remote-loop-detect interface [ethernet [<i>interface-list</i>]]	
Disable remote-loop-detect	undo stp remote-loop-detect interface [ethernet [<i>interface-list</i>]]	
Enter the interface configuration mode.	interface { { ethernet <i>interface-num</i> } <i>interface-name</i> }	
Enable remote-loop-detect	stp remote-loop-detect	
Disable remote-loop-detect	undo stp remote-loop-detect	

13.2.2 Configure the Processing Policy

When Remote-loop-detect detects the existence of loop, there are two ways: one is discarding the port, the other is the port shutdown, and then periodically restores the port; the default use discarding.

Operation	Command	Remarks
Enter the global configuration mode.	system-view	
Configure the processing policy	stp remote-loop-detect action { shutdown discarding }	Discarding by default

13.2.3 Configure the Interval Timer

Operation	Command	Remarks
-----------	---------	---------

Enter the global configuration mode.	system-view	
Configure the processing policy	stp remote-loop-detect interval-time <i>interval-time</i>	5s by default

13.2.4 Configure the Recovery Timer

When Remote-loop-detect detects that a loop exists and the shutdown command is used, the shutdown port periodically recovers the corresponding port. The default recovery period is 20 seconds and can be modified as needed. If it is configured as 60s, it means that it will not be automatically restored. User needs to manually run the shutdown / no shutdown command on the port. The port can re-linkup.

Operation	Command	Remarks
Enter the global configuration mode	system-view	
Configure the shutdown processing policy	stp remote-loop-detect action shutdown	
Configure the recovery time of the port	stp remote-loop-detect recover-time <i>recover-time</i>	

13.2.5 Display Remote-loop-detect Configuration

Operation	Command	Remarks
Display remote-loop-detect Configuration	display stp remote-loop-detect interface [ethernet [interface-list]]	

Chapter 14 ACL

14.1 ACL Overview

14.1.1 ACL Overview

As network scale and network traffic are increasingly growing, network security and bandwidth allocation become more and more critical to network management. Packet filtering can be used to efficiently prevent illegal users from accessing networks and to control network traffic and save network resources. Access control lists (ACL) are often used to filter packets with configured matching rules.

ACLs are sets of rules (or sets of permit or deny statements) that decide what packets can pass and what should be rejected based on matching criteria such as source MAC address, destination MAC address, source IP address, destination IP address, and port number.

When an ACL is assigned to a piece of hardware and referenced by a QoS policy for traffic classification, the GPON does not take action according to the traffic behavior definition on a packet that does not match the ACL.

ACL according to application identified by ACL numbers, fall into three categories,

Basic ACL: Source IP address

Extended ACL: Source IP address, destination IP address, protocol carried on IP, and other Layer 3 or Layer 4 protocol header information

Layer 2 ACL: Layer 2 protocol header fields such as source MAC address, destination MAC address, 802.1p priority, and link layer protocol type.

14.2 ACL Configuration

14.2.1 ACL Configuration List

Configuration Task	Description	Detailed Configuration
Configure Match Order	Optional	14.2.2
Configure Time Range	Optional	14.2.3
Configure Basic ACL	Required	14.2.4
Configure Extended ACL	Required	14.2.5
Configure Layer 2 ACL	Required	14.2.6
Activate ACL	Required	14.2.7
Display and Debugging ACL	Optional	14.2.8

14.2.2 Configure Match Order

An ACL consists of multiple rules, each of which specifies different matching criteria. These criteria may have overlapping or conflicting parts. This is where the order in which a packet is matched against the rules comes to rescue.

Two match orders are available for ACLs:

config: where packets are compared against ACL rules in the order in which they are configured.

auto: where depth-first match is performed. The term depth-first match has different meanings for different types of ACLs. Depth-first match for a basic ACL

For example, now Configure 2 types of ACL as below:

```
[GPON]acl 2000 deny any
```

```
Config ACL subitem successfully.
```

```
[GPON]acl 2000 permit 1.1.1.1 0
```

```
Config ACL subitem successfully.
```

1) If it is the configuration mode, sub-item 0 is the first command. You can see as below configuration:

```
[GPON]display acl config 1
```

```
Standard IP Access List 1, match-order is config, 2 rule:
```

```
0 deny any
```

```
1 permit 1.1.1.1 0.0.0.0
```

2) If it is the auto mode, sub-item 0 is the longest ACL match rule. You can see as below configuration:

```
[GPON]display acl config 1
```

```
Standard IP Access List 1, match-order is auto, 2 rule:
```

```
0 permit 1.1.1.1 0.0.0.0
```

```
1 deny any
```

Notes, ACL must enable. GPONes must obey “first enable then active. Please refer to Chapter 1.6 for detailed configuration.

14.2.3 Configure Time Range

There are two kinds of configuration: configure absolute time range and periodic time range. Configure absolute is in the form of year, month, date, hour and minute. Configure periodic time range is in the form of day of week, hour and minute.

Operation	Command	Remarks
Enter global configuration mode	system-view	
new build time range and enter time range mode	time-range <i>name</i>	
Configure absolute start	absolute start <i>HH:MM:SS YYYY/MM/DD</i> [end <i>HH:MM:SS YYYY/MM/DD</i>]	
Configure periodic start	periodic <i>days-of-the-weekhh:mm:ss to</i> [<i>day-of-the-week</i>] <i>hh:mm:ss</i>	

Note:

Periodic time range created using the time-range time-name start-time to end-time days command. A time range thus created recurs periodically on the day or days of the week.

Absolute time range created using the time-range time-name {from time1 date1 [to time2 date2] | to time2 date2 } command. Unlike a periodic time range, a time range thus created does not recur. For example, to create an absolute time range that is active between January 1, 2004 00:00 and December 31, 2004 23:59, you may use the time-range test from 00:00

01/01/2004 to 23:59 12/31/2004 command.

Compound time range created using the time-range time-name start-time to end-time days { from time1 date1 [to time2 date2] | to time2 date2 } command. A time range thus created recurs on the day or days of the week only within the specified period. For example, to create a time range that is active from 12:00 to 14:00 on Wednesdays between January 1, 2004 00:00 and December 31, 2004 23:59, you may use the time-range test 12:00 to 14:00 Wednesday from 00:00 01/01/2004 to 23:59 12/31/2004 command.

You may create individual time ranges identified with the same name. They are regarded as one time range whose active period is the result of ORing periodic ones, ORing absolute ones, and ANDing periodic and absolute ones.

With no start time specified, the time range is from the earliest time that the system can express (that is, 00:00 01/01/1970) to the end time. With no end time specified, the time range is from the time the configuration takes effect to the latest time that the system can express (that is, 24:00 12/31/2100).

Up to 256 time ranges can be defined.

Configuration Examples

Create an absolute time range from 16:00, Jan 3, 2009 to 16:00, Jan 5, 2009

```
<GPON>system-view
```

```
[GPON]time-range b
```

Config time range successfully.

```
[GPON-timerange-b]absolute start 16:00:00 2009/1/3 end 16:00:00 2009/1/5
```

Config absolute range successfully .

```
[GPON-timerange-b]display time-range name b
```

```
Current time is: 02:46:43 2009/01/31 Saturday
```

```
time-range: b ( Inactive )
```

```
absolute: start 16:00:00 2009/01/03 end 16:00:00 2009/01/05
```

Create a periodic time range that is active from 8:00 to 18:00 every working day.

```
<GPON>system-view
```

```
[GPON]time-range b
```

```
Config time range successfully.
```

```
[GPON-timerange-b]periodic weekdays 8:00:00 to 18:00:00
```

```
Config periodic range successfully .
```

```
[GPON-timerange-b]display time-range name b
```

```
Current time is: 02:47:56 2009/01/31 Saturday
```

```
time-range: b ( Inactive )
```

```
periodic: weekdays 08:00 to 18:00
```

14.2.4 Configure Basic ACL

GPON support ACL as below:

1)Basic ACL

2)Extended ACL

3)Layer 2 AC

Basic ACLs filter packets based on source IP address. They are numbered in the range 1 to 99.

At most 99 ACL with number mark and at most 1000 ACL with name mark. At most 128 rules for each ACL at the same time. If you want to reference a time range to a rule, define it with the

time-range command first.

Follow these steps to configure a basic ACL.

Operation	Command	Remarks
Enter global configuration mode	system-view	
Define sub-item match rule	acl num match-order { config auto }	By default, system is config
Define basic ACL	acl num { permit deny } { source-IPv4/v6 source-wildcard any ipv6any } [time-range name]	

Configure basic ACL based on name identification

Operation	Command	Remarks
Enter global configuration mode	system-view	
Define sub-item match rule	acl standard name match-order { config auto }	by default, system is config
Define basic ACL and enter configuration mode	acl standard name	
Configure ACL rule	{ permit deny } { source-IPv4/v6 source-wildcard any ipv6any } [time-range name]	

Configure Examples

!Define a basic ACL with number mark to deny packet with source IP 10.0.0.1

```
<GPON>system-view
```

```
[GPON]acl 1 deny 10.0.0.1 0
```

!Define a basic ACL with name mark to deny packet with source IP 10.0.0.2

```
<GPON>system-view
```

```
[GPON]acl standard stdacl
```

```
[GPON-std-nacl-stdacl]deny 10.0.0.2 0
```

14.2.5 Configure Extended ACL

GPON can define at most 100 extended ACL with the number ID (the number is in the range of 100 to 199), at most 1000 extended ACL with the name ID. It can define 128 sub-rules for an ACL (this rule can suit both ACL with name ID and number ID).

Follow these steps to configure a extended ACL.

Operation	Command	Remarks
Enter global configuration mode	system-view	-
Define sub-item match rule	acl num match-order { config auto }	by default ,system is config
Define extended ACL	acl num { permit deny } [protocol] [established] { source-IPv4/v6 source-wildcard any ipv6any } [port [portmask]] { dest- IPv4/v6 dest-wildcard any ipv6any } [port [portmask]] { [precedence precedence] [tos tos] [dscp dscp] } [time-range name]	required

Configure extended ACL based on name identification

Operation	Command	Remarks
Enter global configuration mode	system-view	
Define subitem match rule	acl extended name match-order { config auto }	
		by

		default ,system is config
Define extended ACL and enter configuration mode	acl extended name	
Configure ACL rule	{ permit deny } [<i>protocol</i>] [established] { <i>source-IPv4/v6</i> <i>source-wildcard</i> any ipv6any } [<i>port</i> [<i>portmask</i>]] { <i>dest-IPv4/v6</i> <i>dest-wildcard</i> any ipv6any } [<i>port</i> [<i>portmask</i>]] { [precedence <i>precedence</i>] [tos tos] [dscp dscp] } [time-range <i>name</i>]	

Detailed parameters of extended ACL as below Table:

Parameters	Function	Remark
<i>protocol</i>	IP protocol type carried	A number in the range of 1 to 255. Represented by name, you can select GRE, ICMP, IGMP, IPinIP, OSPF, TCP, UDP
<i>source-IPv4/v6</i>	ACL rules specified the source address information	source-IPv4/v6 used to determine the packet's source IP address. Dotted decimal notation;
<i>source-wildcard</i>		sour-wildcard of 0 means

		that the host address
any		any source address.
dest-IPv4/v6	The purpose of ACL rules specified address information	dest-IPv4/v6 used to determine the packet destination address, in dotted decimal notation;
dest-wildcard any		dest-wildcard is 0, the host address; Any is any destination address.
port	TCP / UDP port number	—
precedence	priority precedence message	IP precedence values range from 0 to 7
tos	tos priority packets	ToS priority ranges from 0 to 15
dscp	DSCP priority	Rule applies only to non-first fragment packet effective
	Level ranges from 0 to 63	
	fragment fragmentation information	
name	Create a time range	—

Configuration Examples

!Create extended ACL based on digital identification to deny the FTP packets with source

address 10.0.0.1 .

```
<GPON>system-view
```

```
[GPON]acl 100 deny tcp 10.0.0.1 0 ftp any
```

!Create extended ACL based on name identification to deny the FTP packets with source

address 10.0.0.1.

```
<GPON>system-view
```

```
[GPON]acl extended extacl
```

```
[GPON-ext-nacl-extacl] deny tcp 10.0.0.2 0 ftp any
```

14.2.1 Configure Layer 2 ACL

GPON can define at most 100 layer 2 ACL with the number ID (the number is in the range of 200 to 299), at most 1000 layer 2 ACL with the name ID. It can define 128 sub-rules for an ACL (this rule can suit both ACL with name ID and number ID). Layer 2 ACL only classifies data packet according to the source MAC address, source VLAN ID, layer protocol type, layer packet received and retransmission interface and destination MAC address of layer 2 frame head of data packet and analyze the matching data packet.

Follow these steps to configure a Layer 2 ACL.

Operation	Command	Remarks
Enter global configuration mode	system-view	
Define sub-item match rule	acl num match-order { config auto }	by default ,system is config
Define Layer 2 ACL	acl num { permit deny } [protocol] [cos	

	<pre> vlan-pri] ingress { { [source-vlan-id] [source-mac-addr source-mac-wildcard] [interface interface-num] } any } egress { { [dest-mac-addr dest-mac-wildcard] [interface interface-num cpu] } any } [time-range name] </pre>	
--	---	--

Configure Layer 2 ACL based on name identification

Operation	Command	Remarks
Enter global configuration mode	system-view	
Define sub-item match rule	acl link name match-order { config auto }	By default , system is config
Define Layer 2 ACL and enter configuration mode	acl link name	
Configure ACL rule	<pre> { permit deny } [protocol] [cos vlan-pri] ingress { { [source-vlan-id] [source-mac-addr source-mac-wildcard] [interface interface- num] } any } egress { { [dest-mac-addr dest-mac-wildcard] [interface interface-num cpu] } any } [time-range name] </pre>	

Configuration Examples

!Create Layer 2 ACL based on digital identification to deny the MAC with ARP address 00:00:00:00:00:01.

```
<GPON>system-view
```

```
[GPON]acl 200 deny arp ingress 00:00:00:00:00:01 0 egress any
```

!Create Layer 2 ACL based on name identification to deny the MAC with ARP address 00:00:00:00:00:02.

```

<GPON>system-view
[GPON]acl link lnkacl
[GPON-link-nacl-lnkacl] deny arp ingress 00:00:00:00:00:02 0 egress any

```

14.2.2 Activate ACL

GPON obey the rule of “**First enable then active**”

Operation	Command	Remarks
Enter global configuration mode	system-view	
Active ACL	access-group [ip-group name num] [subitem num] [link-group name num] [subitem num]	

Configuration Examples

GPONes only permit with source IP address 1.1.1.1

!Before configuration

```
[GPON]display acl config 1
```

Standard IP Access List 2, match-order is config, 2 rule:

```
0 deny any
```

```
1 permit 1.1.1.1 0.0.0.0
```

!Configuration steps

```
[GPON]access-group ip-group 1 subitem 1
```

Activate ACL successfully .

```
[GPON]access-group ip-group 1 subitem 0
```

Activate ACL successfully .

!Before configuration

```
[GPON]display acl config 1
```

Standard IP Access List 1, match-order is auto, 2 rule:

```
0 permit 1.1.1.1 0.0.0.0
```

```
1 deny any
```

!Configuration steps

```
[GPON]access-group ip-group 1
```

Activate ACL successfully .

Active ACL Binding

IP+MAC+Port binds through ACL binding active.

!Configuration request

MAC is 00:00:00:00:00:01, IP address of 1.1.1.1,the user can only enter from e0/0/1 mouth.

!Configuration steps

```
[GPON]acl 1 permit 1.1.1.1 0
```

```
[GPON]acl 200 permit ingress 00:00:00:00:00:01 0 interface ethernet 0/0/1 egress any
```

```
[GPON]acl 210 deny ingress any egress any
```

```
[GPON]access-group ip-group 1 link-group 200
```

```
[GPON]access-group link-group 210
```

14.2.3 Display and Debugging ACL

After finishing above configuration, you can see configuration as below commands.

Operation	Command	Remarks
-----------	---------	---------

Display ACL statistics	display acl config statistic	
Display ACL configuration	display acl config { all num name name }	
Display ACL runtime information	display acl runtime { all num name name }	

Chapter 15 QOS

15.1 QOS Overview

In traditional IP networks, packets are treated equally. That is, the FIFO (first in first out) policy is adopted for packet processing. Network resources required for packet forwarding is determined by the order in which packets arrive. All the packets share the resources of the network. Network resources available to the packets completely depend on the time they arrive. This service policy is known as Best-effort, which delivers the packets to their destination with the best effort, with no assurance and guarantee for delivery delay, jitter, packet loss ratio, reliability, and so on.

With the fast development of computer networks, more and more networks are connected into Internet. Users hope to get better services, such as dedicated bandwidth, transfer delay, jitter voice, image, important data which enrich network service resources and always face network congestion. Internet users bring forward higher requirements for QoS. Ethernet technology is the widest network technology in the world recently. Now, Ethernet becomes the leading technology in every independent LAN, and many LAN in the form of Ethernet have become a part of internet. With the development of Ethernet technology, Ethernet connecting will become one of main connecting for internet users. To execute end-to-end QoS solution has to consider the service guarantee of Ethernet QoS, which needs Ethernet device applies to

Ethernet technology to provide different levels of QoS guarantee for different types of service flow, especially the service flow highly requiring delay and jitter.

15.1.1 Traffic

Traffic means all packets through GPON.

15.1.2 Traffic Classification

Traffic classification is to identify packets conforming to certain characters according to certain rules. It is the basis and prerequisite for providing differentiated services. A traffic classification rule can use the precedence bits in the type of service (ToS) field of the IP packet header to identify traffic with different precedence characteristics. A traffic classification rule can also classify traffic according to the traffic classification policy set by the network administrator, such as the combination of source address, destination address, MAC address, IP protocol, or the port numbers of the application. Traffic classification is generally based on the information in the packet header and rarely based on the content of the packet.

15.1.3 Priority

1) 802.1p priority lies in Layer 2 packet headers and is applicable to occasions where the Layer 3 packet header does not need analysis but QoS must be assured at Layer 2. As shown in the chapter of VLAN configuration. Each host supported 802.1Q protocol forwards packets which are from Ethernet frame source address add a 4-byte tag header.

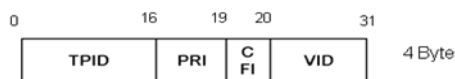

As shown in the figure above, PRI segment is 802.1p priority. It consists of 3bits whose range from 0~7. The three bits point the frame priority. The tag including 8 formats gives the precedence to forward the packets.

cos (decimal)	cos (binary)	Description
0	000	spare
1	001	background
2	010	best-effort
3	011	excellent-effort
4	100	controlled-load
5	101	video
6	110	voice
7	111	network-management

2) IP precedence, TOS precedence, and DSCP values

The TOS field in the IP header contains eight bits: the first three bits represent IP precedence; the subsequent four bits represent a ToS value and 1 bit with currently unused defaults 0. The four bits of TOS packets are grouped into four classes: the smallest time delay, maximum rate, highly reliability, minimum cost. Only 1 bit can be set, if the DSCP values equal 0, that means normal service.

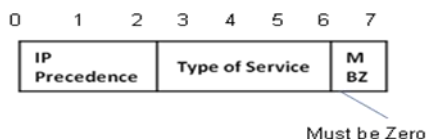

IP precedence contains 8 formats.

IP Precedence (decimal)	IP Precedence (binary)	Description
0	000	routine
1	001	priority
2	010	immediate
3	011	flash
4	100	flash-override
5	101	critical
6	110	internet
7	111	network

TOS precedence contains 5 formats.

TOS (decimal)	TOS (binary)	Description
0	0000	normal
1	0001	min-monetary-cost
2	0010	max-reliability
4	0100	max-throughput
8	1000	min-delay

According to RFC 2474, the ToS field is redefined as the differentiated services (DS) field, where a DSCP value is represented by the first six bits (0 to 5) and ranges from 0 to 63. The remaining two bits (6 and 7) are reserved.

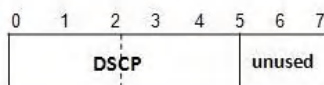

In a network in the Diff-Serve model, traffic is grouped into the following classes, and packets are processed according to their DSCP values

Expedited forwarding (EF) class: In this class, packets are forwarded regardless of link share of other traffic. The class is suitable for preferential services requiring low delay, low

packet loss, low jitter, and high bandwidth.

Assured forwarding (AF) class: This class is divided into four subclasses (AF 1 to AF 4), each containing three drop priorities for more granular classification. The QoS level of the AF class is lower than that of the EF class.

Class selector (CS) class: This class is derived from the IP ToS field and includes eight subclasses.

Best effort (BE) class: This class is a special CS class that does not provide any assurance. AF traffic exceeding the limit is degraded to the BE class. All IP network traffic belongs to this class by default.

DSCP (decimal)	DSCP (binary)	keys
0	000000	be
46	101110	ef
10	001010	af1
18	010010	af2
26	011010	af3
34	100010	af4
8	001000	cs1
16	010000	cs2
24	011000	cs3
32	100000	cs4
40	101000	cs5
48	110000	cs6
56	111000	cs7

15.1.4 Access Control List

To classify flow is to provide service distinctively which must be connected resource distributing. To adopt which kind of flow control is related to the stage it is in and the current load of the network. For example: monitor packet according to the promised average speed rate when the packet is in the network and queue scheduling manage the packet before it is out of the node.

15.1.5 Packet Filtration

Packet filtration is to filtrate service flow, such as deny, that is, deny the service flow which is matching the traffic classification, and permit other flows to pass. System adopts complicated flow classification to filtrate all kinds of information of service layer 2 packets to deny useless, unreliable, and doubtful service flow to strengthen network security.

Two key points of realizing packet filtration:

Step 1: Classify ingress flows according to some regulation;

Step 2: Filtrate distinct flow by denying. Deny is default accessing control.

15.1.6 Flow Monitor

In order to serve customers better with the limited network resources, QoS can monitor service flow of specified user in ingress interface, which can adapt to the distributed network resources.

15.1.7 Interface Speed Limitation

Interface speed limitation is the speed limit based on interface which limits the total speed rate of interface outputting packet.

15.1.8 Redirection

User can re-specify the packet transmission interface based on the need of its own QoS strategies.

15.1.9 Priority Mark

Ethernet GPON can provide priority mark service for specified packet, which includes: TOS, DSCP, 802.1p. These priority marks can adapt different QoS model and can be defined in these different models.

15.1.10 Choose Interface Outputting Queue for Packet

Ethernet GPON can choose corresponding outputting queue for specified packets.

15.1.11 Queue Scheduler

It adopts queue scheduler to solve the problem of resource contention of many packets when network congestion. There are three queue scheduler matchings: Strict-Priority Queue (PQ), Weighted Round Robin (WRR) and WRR with maximum delay.

1) PQ

PQ (Priority Queuing) is designed for key service application. Key service possesses an important feature, that is, require the precedent service to reduce the response delay when

network congestion. Priority queue divides all packets into 4 levels, that is, superior priority, middle priority, normal priority and inferior priority (3, 2, 1, 0), and their priority levels reduce in turn.

When queue scheduler, PQ precedently transmits the packets in superior priority according to the priority level. Transmit packet in inferior priority when the superior one is empty. Put the key service in the superior one, and non-key service (such as email) in inferior one to guarantee the packets in superior group can be first transmitted and non-key service can be transmitted in the spare time.

The shortage of PQ is: when there is network congestion, there are more packets in superior group for a long time, the packets in inferior priority will wait longer.

2) WRR

WRR queue scheduler divides a port into 4 or 8 outputting queues (S2926V-O has 4 queues, that is, 3, 2, 1, 0) and each scheduler is in turn to guarantee the service time for each queue. WRR can configure a weighted value (that is, w_3 , w_2 , w_1 , w_0 in turn) which means the percentage of obtaining the resources. For example: There is a port of 100M. Configure its WRR queue scheduler value to be 50, 30, 10, 10 (corresponding w_3 , w_2 , w_1 , w_0 in turn) to guarantee the inferior priority queue to gain at least 10Mbit/s bandwidth, to avoid the shortage of PQ queue scheduler in which packets may not gain the service.

WRR possesses another advantage. The scheduler of many queues is in turn, but the time for service is not fixed-if some queue is free, it will change to the next queue scheduler to make full use of bandwidth resources.

3) SP+ WRR

Superior priority or less priority use SP algorithm, others use WRR algorithm.

15.1.12 Cos-map Relationship of Hardware Priority Queue and Priority of IEEE802.1p Protocol

System will map between 802.1p protocol priority of packet and hardware queue priority. For each packet, system will map it to specified hardware queue priority according to 802.1p protocol priority of packet.

15.1.13 Flow Mirror

Flow mirror means coping specified data packet to monitor interface to detect network and exclude failure.

15.1.14 Statistics Based on Flow

Statistics based on flow can statistic and analyze the packets customer interested in.

15.1.15 Copy Packet to CPU

User can copy specified packet to CPU according to the need of its QoS strategies.

System realizes QoS function according to accessing control list, which includes: flow monitor, interface speed limit, packet redirection, priority mark, queue scheduler, flow mirror, flow statistics, and coping packet to CPU.

15.2 Configure QoS

15.2.1 QoS Configuration List

Configuration Task	Description	Detailed Configuration
Configure Flow Monitor	Required	15.2.2
Configure Two Rate Three Color Marker	Required	15.2.3
Configure Interface Line Rate	Required	15.2.4
Configure Packet Redirection	Required	15.2.5
Configure Traffic Copy to CPU	Required	15.2.6
Configure Traffic Priority	Required	15.2.7
Configure Queue-Scheduler	Optional	15.2.8
Configure Cos-map Relationship of Hardware Priority Queue and Priority of IEEE802.1p Protocol	Optional	15.2.9
Configure Mapping Relationship between DSCP and 8 Priority in IEEE 802.1p	Optional	15.2.10
Configure Flow Statistic	Required	15.2.11
Configure Flow Mirror	Required	15.2.12
Display and Maintain QoS	Optional	15.2.13

15.2.2 Configure Flow Monitor

Flow monitor is restriction to flow rate which can monitor the speed of a flow entering GPON. If the flow is beyond specified specification, it will take actions, such as dropping packet or reconfigure their priority.

Operation	Command	Remarks
Enter globally configuration mode	system-view	
Configure flow rate	rate-limit { input output } { [ip-group { num name } [subitem subitem]] [link-group { num name } [subitem subitem]] } target-rate	

15.2.3 Configure Two Rate Three Color Marker

Two Rate Three Color Marker is defined in RFC 2698. There is 4 parameter for it: CIR, CBS, PIR and PBS.

Operation	Command	Remarks
Enter globally configuration mode	system-view	
Configure Two Rate Three Color Mode	two-rate-policer mode { color-aware color-blind }	
Configure Two Rate Three Color pre-color	two-rate-policer set-pre-color dscp-value { green red yellow }	
Configure Two Rate Three Color Marker	rate-limit input { [ip-group { acl-number acl-name } [subitem subitem]] [link-group { acl-number acl-name } [subitem subitem]] } target-rate two-rate-policercir cir cbs cbs pir pir pbs pbs conform-action { copy-to-cpu drop set_dscp_value dscp transmit exceed-action { copy-to-cpu drop set_dscp_value dscp transmit } }	

	violate-action { copy-to-cpu drop set_dscp_value <i>dscp</i> transmit }	
--	--	--

15.2.4 Configure Interface Line Rate

Line-limit is the speed limit based on interface which restricts the total speed of packet outputting.

Operation	Command	Remarks
Enter globally configuration mode	system-view	
Enter port configuration mode	interface ethernet <i>interface-num</i>	
Configure egress rate	bandwidth egress kbps <i>target-rate</i>	
Configure ingress rate	bandwidth ingress kbps <i>target-rate</i>	

15.2.5 Configure Packet Redirection

Packet redirection configuration is redirecting packet to be transmitted to some egress.

Operation	Command	Remarks
Enter globally configuration mode	system-view	
Configure packet redirection	traffic-redirect { [ip-group { <i>num</i> <i>name</i> } [subitem <i>subitem</i>]] [link-group { <i>num</i> <i>name</i> } [subitem <i>subitem</i>]] } { [interface <i>interface-num</i> cpu] }	

15.2.6 Configure Traffic Copy to CPU

GPON automatically copies to CPU after Configure traffic copy to CPU.

Operation	Command	Remarks
-----------	---------	---------

Enter globally configuration mode	system-view	
Configure traffic copy to CPU	traffic-copy-to-cpu { [ip-group { <i>num</i> <i>name</i> } [subitem <i>subitem</i>]] [link-group { <i>num</i> <i>name</i> } [subitem <i>subitem</i>]] }	

15.2.7 Configure Traffic Priority

Traffic priority configuration is the strategy of remark priority for matching packet in ACL, and the marked priority can be filled in the domain which reflects priority in packet head.

Operation	Command	Remarks
Enter globally configuration mode	system-view	
Configure traffic priority	traffic-priority { [ip-group { <i>num</i> <i>name</i> } [subitem <i>subitem</i>]] [link-group { <i>num</i> <i>name</i> } [subitem <i>subitem</i>]] } { [dscp <i>dscp-value</i>] [cos { <i>pre-value</i> from-ipprec }] [local-precedence <i>pre-value</i>] }	

15.2.8 Configure Queue-Scheduler

When network congestion, it must use queue-scheduler to solve the problem of resource competition. System supports 3 kinds of queue-scheduler, that is SP, WRR and full SP+WRR.

By default is SP in system.

Operation	Command	Remarks
Enter globally configuration mode	system-view	
Configure SP	queue-scheduler <i>group-number</i> strict-priority	

Configure WRR	queue-scheduler group-number wrr <i>queue1-weight queue2-weight</i> <i>queue3-weight queue4-weight</i> <i>queue5-weight queue6-weight</i> <i>queue7-weight queue8-weight</i>	
Configure SP+WRR	queue-scheduler group-number sp-wrr <i>queue1-weight queue2-weight</i> <i>queue3-weight queue4-weight</i> <i>queue5-weight queue6-weight</i> <i>queue7-weight queue8-weight</i>	
Enter port configuration mode	interface ethernet interface-num	
Configure queue-scheduler on interface	queue-scheduler group-number	

15.2.9 Configure Cos-map Relationship of Hardware Priority Queue and Priority of IEEE802.1p Protocol

The cos-map relationship of hardware priority queue and priority of IEEE802.1p protocol is one-to-one correspondence. Administrators change the cos-map relationship of hardware priority queue and priority of IEEE802.1p protocol timely when the one-to-one correspondence shifting.

By default, the cos-map relationship of hardware priority queue and priority of IEEE802.1p protocol as below:

802.1p	hardware priority queue
0	0
1	1
2	2
3	3
4	4
5	5
6	6
7	7

Administrators also change the cos-map relationship of hardware priority queue and priority of IEEE802.1p protocol according to the actual network.

Operation	Command	Remarks
Enter globally configuration mode	system-view	
Modify 802.1p and cos-map relationship of hardware priority queue	queue-scheduler cos-map <i>cos-map-group</i> <i>queue-number 802.1p-priority</i>	
Enter port configuration mode	interface ethernet <i>interface-num</i>	
Configure cos-map on interface	queue-scheduler cos-map <i>cos-map-group</i>	

15.2.10 Configure Mapping Relationship between DSCP and 8 Priority in IEEE 802.1p

The same situation as 1.2.7, by default, the relation between DSCP and 8 priority in IEEE 802.1p as below:

SCP	hardware priority queue	DSCP	hardware priority queue	DSCP	hardware priority queue	DSCP	hardware priority queue
0	0	16	2	32	4	48	6
1	0	17	2	33	4	49	6
2	0	18	2	34	4	50	6
3	0	19	2	35	4	51	6
4	0	20	2	36	4	52	6
5	0	21	2	37	4	53	6
6	0	22	2	38	4	54	6
7	0	23	2	39	4	55	6
8	1	24	3	40	5	56	7
9	1	25	3	41	5	57	7
10	1	26	3	42	5	58	7
11	1	27	3	43	5	59	7
12	1	28	3	44	5	60	7
13	1	29	3	45	5	61	7
14	1	30	3	46	5	62	7
15	1	31	3	47	5	63	7

Administrators also change the mapping relationship between DSCP and 8 priority in IEEE 802.1p according to the actual network.

Operation	Command	Remarks
Enter globally configuration mode	system-view	
save the relation between DSCP and 8 priority in IEEE 802.1p	queue-scheduler dscp-map	
Modify the relation between DSCP and 8 priority in IEEE 802.1p	queue-scheduler dscp-map <i>dscp-map-group dscp-value queue-number</i>	
Enter port configuration mode	interface ethernet <i>interface-num</i>	
Configure cos-map on interface	queue-scheduler dscp-map <i>dscp-map-group</i>	

15.2.11 Configure Flow Statistic

Flow statistic configuration is used to statistic specified service flow packet. The statistic is accumulated value and reset to zero when re-Configure.

Operation	Command	Remarks
Enter globally configuration mode	system-view	
Configure flow statistic	traffic-statistic { [ip-group { <i>num</i> <i>name</i> } [subitem <i>subitem</i>]] [link-group { <i>num</i> <i>name</i> } [subitem <i>subitem</i>]] }	
reset to Zero	clear traffic-statistic { [all] [ip-group { <i>num</i> <i>name</i> } [subitem <i>subitem</i>]] [link-group { <i>num</i> <i>name</i> } [subitem <i>subitem</i>]]] }	

15.2.12 Configure Flow Mirror

Flow mirror is copying the service flow which matches ACL rules to specified monitor interface to analyze and monitor packet.

Operation	Command	Remarks
Enter globally configuration mode	system-view	
Configure flow mirror	mirrored-to { [ip-group { <i>num</i> <i>name</i> } [subitem <i>subitem</i>]] [link-group { <i>num</i> <i>name</i> } [subitem <i>subitem</i>]] } interface <i>interface-num</i>	

15.2.13 Display and Maintain QoS

After finishing above configuration, please use below commands to display the configuration.

Operation	Command	Remarks
Display all the informaion of QoS	display qos-info all	
Display QoS statistic	display qos-info statistic	
Display queue-scheduler mode and parameters	display queue-scheduler	
Display the cos-map relationship of hardware priority queue and priority of IEEE802.1p protocol	display queue-scheduler cos-map [<i>cos-map-group</i>]	
Display the dscp-map relationship of hardware priority queue and priority of IEEE802.1p protocol	display queue-scheduler dscp-map [<i>dscp-map-group</i>]	
Display all QoS port configuration	display qos-interface [interface ethernet	

	<i>interface-num] all</i>	
Display rate-limit parameters	display qos-interface [interface ethernet <i>interface-num] rate-limit</i>	
Display interface line rate parameters	display bandwidth [interface ethernet <i>interface-num]</i>	
Display QoS interface statistic parameters	display qos-interface statistic	
Display traffic-priority parameters	display qos-info traffic-priority	
Display traffic-redirect parameters	display qos-info traffic-redirect	
Display packet redirection	display qos-info traffic-statistic	
Display information of traffic copy to CPU	display qos-info traffic-copy-to-cpu	

Chapter 16 SSH

16.1 SSH Overview

Secure Shell (SSH) can provide information security and powerful authentication to prevent such assaults as IP address spoofing, plain-text password interception when users log on to the GPON remotely through an insecure network environment.

SSH can take the place of the Telnet to provide safe management and configuration.

16.2 Configure SSH Server

A GPON, as a SSH server, can connect to multiple SSH clients. SSH clients can be both LAN users and WAN users. XXXX GPONes can only SSH server and support SSH v2.

The following table describes SSH server configuration tasks.

Operation	Command	Remarks
Enterprivileged configuration mode	enable	
Configure the default key	ssh-server key create { rsa dss ecdsa }	
Clear configured key	ssh-server key delete { rsa dss ecdsa }	
Enter globally configuration mode	system-view	-
Enable SSH	ssh-server	By default, this function is disabled.

Disable SSH	undo ssh-server	
Config SSH User limit	ssh-server limit <i>max-num</i>	
Display SSH	display ssh-server	
Display SSH user limit	display ssh-server limit	

16.3 Log in GPON from SSH Client

To successfully establish SSH connection, pay attention to following points:

- 1) Create the connection between SSH client and server.
- 2) The version of client and server should be the same.
- 3) SSH function in server should be enabled.

Chapter 17 SNMP

17.1 SNMP Overview

SNMP (Simple Network Management Protocol) is an important network management protocol on TCP / IP networks, implementing network management by exchanging packets on the network. The SNMP protocol provides the possibility of centralized management of large networks. Its goal is to ensure the management information is transmitted between any two points. SNMP is convenient for the network administrator to retrieve information from any node on the network, make modifications, find faults, and complete fault diagnosis, capacity planning and report generation.

SNMP structure is divided into two parts: NMS and Agent. NMS (Network Management Station) is a workstation that runs client programs while Agent is a server-side software running on a network device. The NMS can forward GetRequest, GetNextRequest, and SetRequest packets to the Agent. Upon receiving the NMS request message, the agent performs Read or Write operations according to the packet type and generates a Response packet to return to the NMS. On the other hand, when the device encounters an abnormal event such as hot / cold start, the agent will forward a trap packet to NMS to report the events.

The system supports SNMP v1, SNMP v2c and SNMP v3. SNMP V1 provides a simple authentication mechanism, does not support the administrator-to-manager communications, and v1 Trap has no confirmation mechanism. V2c enhanced v1 management model (on

security), management information structure, protocol operation, manager and communication ability between managers to increase the creation and deletion of the table, the communication ability between managers, reducing the storage side of the agent. V3 implements the user authentication mechanism and packet encryption mechanism, which greatly improves the security of the SNMP protocol.

This function cooperates with the network management software to log on to the GPON and manage the GPON.

17.2 Configure SNMP-Agent

17.2.1 SNMP-Agent Configuration List

Configuration Task	Description	Detailed Configuration
Configure the Basic Parameters	Required	17.2.2
Configure the Community Name	Required	17.2.3
Configure the Views	Optional	17.2.4
Configure the Group	Optional	17.2.5
Configure the User	Optional	17.2.6
Display SNMP Configuration	Optional	17.2.7

17.2.2 Configure the Basic Parameters

Operation	Command	Remarks
Enter the global configuration mode.	system-view	
Enable/disable SNMP Traps/informs	[undo] snmp-agent enable { informs traps } [<i>notificationtype-list</i>]	
Configure sysContact	[undo] snmp-agent scontact <i>syscontact</i>	
Configure sysLocation	[undo] snmp-agent location <i>syslocation</i>	
Configure sysName	[undo] snmp-agent name <i>sysname</i>	
Configure maximum length of snmp protocol packets	[undo] snmp-agent max-packet-length <i>length</i>	
Configure host	[undo] snmp-agent host <i>host-addr</i> [version { 1 2c 3 [auth noauth priv] }] <i>community-string</i> [udp-port <i>port</i>] [notify-type [<i>notifytype-list</i>]]	
Configure snmp trap-source	[undo] snmp-agent trap-source <i>ipaddress</i>	
Configure snmp-agent engineoid	[undo] snmp-agent engineoid { local <i>engineid-string</i> remote <i>ip-address</i>	

	[<i>udp-port port-number</i>] <i>engineid-string</i> }	
--	--	--

17.2.3 Configure the Community Name

SNMP adopts the community name authentication scheme. SNMP packets that do not match the community name will be discarded. SNMP community is named by a string, known as the community name. Different communities can have read-only or read-write access permission. A community with read-only access can only query system information. However, in addition to query the system information, the community with read-write access permission can perform the system configurations. It defaults to no community name.

Operation	Command	Remarks
Enter the global configuration mode.	system-view	
Configure the community name	snmp-agent community <i>community-name</i> { ro rw } { deny permit } [view <i>view-name</i>]	
Display the community name	display snmp-agent community	
Remove the community name	undo snmp-agent community <i>community-name</i>	

17.2.4 Configure the Views

It is used to configure the views available to access control and the subtrees that they contain. The iso, internet, and sysview exist by default. Delete and modify the internet is not supported.

Operation	Command	Remarks
Enter the global configuration mode.	system-view	
Configure the views	snmp-agent view <i>view-name oid-tree</i> { included excluded }	
Delete the views	undo snmp-agent view <i>view-name</i> [oid-tree]	

17.2.5 Configure the Group

This configuration task can be used to configure an access control group. By default, there are two snmpv3 groups: (1) The initial group with the security level of auth; (2) The initial group with the security level of noauthpriv(No authentication is required and no encryption is required).

Operation	Command	Remarks
Enter the global configuration mode.	system-view	
Configure the group	snmp-agent group <i>groupname</i> { 1 2c 3 [auth noauth priv] [context <i>context-name</i>] } [read <i>readview</i>] [write <i>writeview</i>] [notify <i>notifyview</i>]	
Delete the group	undo snmp-agent group <i>groupname</i> { 1 2c 3 [auth noauth priv] [context <i>context-name</i>] }	

17.2.6 Configure the User

It is used to configure the user for the local engine or for the remote engine that can be identified. By default, the following users exist: (1)initialmd5, (2) initialsha, (3) initialnone.

The above three users are reserved for the system and cannot be used by the user. When Configure a user, you need to ensure that the engine to which this user belongs is identifiable.

When an identifiable engine is deleted, the users it contains are also deleted.

Operation	Command	Remarks
Enter the global configuration mode.	system-view	
Configure the user	snmp-agent user <i>username</i> <i>groupname</i> [remote <i>host</i> [udp-port <i>port</i>]] [auth { md5 sha } { authpassword { encrypt-auth password <i>authpassword</i> authpassword } authkey { encrypt-authkey <i>authkey</i> <i>authkey</i> }} [priv des { privpassword { encrypt-privpassword <i>privpassword</i> <i>privpassword</i> } privkey { encrypt-privkey <i>privkey</i> privkey } }]	
Delete the user	undo snmp-agent user <i>username</i> [remote <i>host</i> [udp-port <i>port</i>]]	

17.2.7 Display SNMP-Agent Configuration

Operation	Command	Remarks
-----------	---------	---------

display snmp community configuration	display snmp community	
display snmp contact configuration	display snmp contact	
display snmp engineid configuration	display snmp engineid { local remote }	
display snmp group configuration	display snmp group	
display snmp host configuration	display snmp host	
display snmp location configuration	display snmp location	
display snmpmax-packet-length configuration	display snmp max-packet-length	
display snmp name configuration	display snmp name	
display snmp notify configuration	display snmp notify	
display snmp user configuration	display snmp user	
display snmp view configuration	display snmp view	

Chapter 18 Info-center

18.1 Info-center Overview

As the information center of the system, the Info-center processes and outputs information in a unified manner.

Other modules in the system send information to be outputted to the Info-center. The Info-center determines the output format based on user configurations and outputs information to the specified display device based on information output functions and filtering rules in user configurations.

Info-center information producers (modules outputting information) only need to output information to the Info-center, without concerning whether information needs to be outputted to the console, telnet terminal, or log host (Info-center server). Information consumers (the console, telnet terminal, history buffer, log host, and SNMP agent) can select the desired information and discard the unwanted information based on their demands, on condition that proper filtering rules are configured.

18.2 Configure Info-center

18.2.1 Info-center Configuration List

Configuration Task	Description	Detailed Configuration
--------------------	-------------	------------------------

Enabling/Disabling the Info-center for the equipment	Required	18.2.2
Configure the function of Display the sequence number in Info-center outputs	Optional	18.2.3
Configure the time stamp type in Info-center outputs	Optional	18.2.4
Configure the function of outputting Info-center information to terminals	Optional	18.2.5
Configure the function of outputting Info-center information to the history buffer	Optional	18.2.6
Configure the function of outputting Info-center information to the flash storage	Optional	18.2.7
Configure the function of outputting Info-center information to the log host	Optional	18.2.8
Configure the function of outputting Info-center information to the SNMP agent	Optional	18.2.9
Configure the module debugging function	Optional	18.2.10

18.2.2 Enabling/Disabling the Info-center for the Equipment

In global configuration mode, enable or disable the Info-center function. When the Info-center function is disabled, no information is outputted. By default, the info-center function is enabled

on the equipment.

Operation	Command	Remarks
Enter the global configuration mode.	system-view	
Enable the log output function of the system.	info-center	
Disable the log output function of the system.	undo info-center	
Display log configurations of the system.	display info-center	

18.2.3 Configure the Function of Display the Sequence Number in Info-center Outputs

In global configuration mode, set to or not to display the global sequence number in Info-center outputs.

Operation	Command	Remarks
Enter the global configuration mode.	system-view	
Enable the function of Display log sequence numbers.	info-center sequence-numbers	
Disable the function of Display log sequence numbers.	undo info-center sequence-numbers	

18.2.4 Configure the Time Stamp Type in Info-center Outputs

In global configuration mode, configure the time stamp type in Info-center outputs. The time stamp type can be set to **notime**, **uptime**, or **datetime**.

The default value is **uptime**.

Operation	Command	Remarks
Enter the global configuration mode.	system-view	
Enable the function of Display the time stamp of logs and configure the time display format.	info-center timestamps { notime uptime datetime }	
Restore the default setting of Display the time stamp of logs.	undo info-center timestamps	

18.2.5 Configure the Function of Outputting Info-center Information to Terminals

In global configuration mode, configure the information output function, information display function, and filtering rules for outputting Info-center information to terminals. By default, Info-center information is outputted only to the buffer and not outputted to the console or terminal.

Operation	Command	Remarks
Enter the global configuration mode.	system-view	

<p>Enable the log output function and output logs to the specified terminal.</p>	<p>info-center monitor { all <i>monitor-num</i> }</p>	<p>When monitor-num is set to 0, logs are outputted to the console. When monitor-num is set to 1–5, logs are outputted to telnet terminals.</p>
<p>Disable the function of outputting logs to a or all terminals.</p>	<p>undo info-center monitor { all <i>monitor-num</i> }</p>	
<p>Return to the privileged mode.</p>	<p>quit</p>	
<p>Enable the function of Display system information.</p>	<p>terminal monitor</p>	<p>Enabled by default, The setting affects only the current login of the current terminal and is invalid for other terminals or the next login</p>

		of the current terminal.
Disable the function of Display system information to prevent outputting any logs to the current terminal.	undo terminal monitor	The setting affects only the current login of the current terminal and is invalid for other terminals or the next login of the current terminal.
Configure the filtering rules of logs to be outputted to terminals. Specify the level and module whose logs are outputted to the specified terminal.	info-center monitor { all <i>monitor-no</i> } { level none level-list { level [to level] } & <1-8> } [module { xxx ... } *]	
Delete the filtering rules of logs to be outputted to the terminals in the system and restore the default configuration.	undo info-center monitor { all <i>monitor-no</i> } filter	

18.2.6 Configure the Function of Outputting Info-center Information to

the History Buffer

In global configuration mode, configure the information output function and filtering rules for outputting Info-center information to the history buffer. By default, the function is enabled.

Operation	Command	Remarks
Enter the global configuration mode.	system-view	
Enable the function of outputting logs to the buffer.	info-center buffered	Enabled by default
Disable the function of outputting logs to the buffer.	undo info-center buffered	
Configure the filtering rules of logs to be outputted to the buffer. Specify the level and module whose logs are outputted to the buffer.	info-center buffered { <i>level</i> none level-list { <i>level</i> [to <i>level</i>] } & < 1-8 > } [module { xxx ... } *]	
Delete the filtering rules of logs to be outputted to the buffer in the system and restore the default configuration.	undo info-center buffered filter	

18.2.7 Configure the Function of Outputting Info-center Information to the Flash Storage

In global configuration mode, configure the information output function and filtering rules for outputting Info-center information to the flash storage. By default, Info-center information is not saved to the flash storage. In addition, the interval of saving Info-center information to the flash storage cannot be configured and the system saves Info-center information once every 30 minutes by default.

Operation	Command	Remarks
Enter the global configuration mode.	system-view	
Enable the function of outputting logs to the flash storage.	info-center flash	
Disable the function of outputting logs to the flash storage.	undo info-center flash	Disabled by default)
Configure the filtering rules of logs to be outputted to the flash storage. Specify the level and module whose logs are outputted to the flash storage.	info-center flash { <i>level</i> none level-list } { <i>level</i> [to <i>level</i>] } & < 1-8 > } [module { xxx ... } *]	
Delete the filtering rules of logs to be outputted to the flash storage in the system and restore the default configuration.	undo info-center flash filter	

18.2.8 Configure the Function of Outputting Info-center Information to the Log Host

In global configuration mode, configure the server address, information output function, filtering rules, info-center tool, and fixed source address for outputting Info-center information to the log host.

Operation	Command	Remarks
Enter the global configuration mode.	system-view	
Configure the IP address of the log host.	info-center ip-address	A maximum of 15 server IP addresses can be configured.
Delete the IP address configured for the log host.	undo info-center ip-address	
Enable the function of outputting logs to the specified host.	info-center host { all ip-address }	
Disable the function of outputting logs to the specified host.	undo info-center host { all ip-address }	

<p>Configure the filtering rules of logs to be outputted to the host. Specify the level and module whose logs are outputted to the host.</p>	<pre>info-center host { all <i>ip-address</i> } { <i>level</i> none level-list { <i>level</i> [to <i>level</i>] } & < 1-8 > } [module { <i>xxx</i> ... } *]</pre>	
<p>Delete the filtering rules of logs to be outputted to the host in the system and restore the default configuration.</p>	<pre>undo info-center host { all <i>ip-address</i> } filter</pre>	
<p>Configure the info-center tool of the system.</p>	<pre>info-center facility { <i>xxx</i> ... }</pre>	
<p>Delete the configured info-center tool name and restore the original setting (localuse7).</p>	<pre>undo info-center facility</pre>	
<p>Configure the fixed source address of log output. ip-address must be set to an interface address of the equipment.</p>	<pre>info-center source <i>ip-address</i></pre>	
<p>Disable the function of outputting logs from the fixed source address.</p>	<pre>undo info-center source</pre>	<p>After the function is disabled, logs will be externally</p>

		sent through the existing IP interface addresses in the system.
--	--	---

18.2.9 Configure the Function of Outputting Info-center Information to the SNMP Agent

In global configuration mode, configure the information output function and filtering rules for outputting Info-center information to the SNMP agent.

To send Info-center information to the SNMP workstation as Trap packets, you must configure the Trap host address. For details, see SNMP configuration.

By default, the function is disabled.

Operation	Command	Remarks
Enter the global configuration mode.	system-view	
Enable the function of outputting logs to the SNMP agent.	info-center snmp-agent	
Disable the function of outputting logs to the SNMP agent.	undo info-center snmp-agent	
Configure the filtering rules of logs to be outputted to the SNMP agent.	info-center snmp-agent { level none level-list { level [to level] } & < 1-8 > }	

Specify the level and module whose logs are outputted to the SNMP agent.	[module { xxx ... } *]	
Delete the filtering rules of logs to be outputted to the SNMP agent in the system and restore the default configuration.	undo info-center snmp-agent filter	

18.2.10 Configure the Module Debugging Function

In global configuration mode, enable/disable the module debugging function. By default, the module debugging function is disabled.

Operation	Command	Remarks
Enter the global configuration mode.	system-view	
Enable the function of outputting the debugging information about the specified module to logs.	debug { all { xxx ... } * }	
Disable the function of outputting the debugging information about the specified module.	undo debug { all { xxx ... } * }	
Display the current configuration of the function of outputting debugging	display debug	

information.		
--------------	--	--

Chapter 19 L3 Base Function

19.1 L3 Base Function Overview

OLT is a 10-Gigabit intelligent routing GPON olt based on the application specific integrated circuit (ASIC) technology and supports layer 2 (L2) and layer 3 (L3) forwarding. It performs L2 forwarding when hosts in the same virtual local area network (VLAN) access each other and L3 forwarding when hosts in different VLANs access each other.

19.2 Configure L3 Base Function

19.2.1 L3 Base Function Configuration List

Configuration Task	Description	Detailed Configuration
Planning VLANs and creating L3 interfaces	Required	19.2.2
Configure the forwarding mode	Optional	19.2.3
Creating VLAN interfaces for common VLANs	Optional	19.2.4
Creating superVLAN interfaces and adding VLANs to the superVLAN	Required	19.2.5
Configure IP addresses for VLAN or superVLAN interfaces	Required	19.2.6

Configure an IP address range for VLAN or superVLAN interfaces	Required	19.2.7
Configure the Address Resolution Protocol (ARP) proxy	Optional	19.2.8
Display interface configurations	Optional	19.2.9
Configure unicast reverse path forwarding (URPF)	Optional	19.2.10
Disabling the function of sending Internet Control Message Protocol (ICMP) packets with an unreachable destination host on interfaces	Optional	19.2.11

19.2.2 Planning VLANs and Creating L3 Interfaces

For details about VLAN planning, see VLAN configurations.

L3 interfaces are classified into common VLAN interfaces and superVLAN interfaces. Common VLAN interfaces are created on VLANs and superVLAN interfaces on superVLANs (superVLANs do not exist or contain any port).

19.2.3 Configure the Forwarding Mode

The L3 GPON supports stream forwarding and network topology-based forwarding. In stream forwarding mode, The L3 GPON identifies the failed route or the unreachable destination host route and sends packets to the CPU for further processing. In network topology-based forwarding mode, The L3 GPON directly discards the packets. By default, The L3 GPON works in stream forwarding mode.

Operation	Command	Remarks
Enter the global configuration mode.	system-view	
Set the packet forwarding mode in the system to stream forwarding.	ip def cpu	
Set the packet forwarding mode in the system to network topology-based forwarding.	undo ip def cpu	
Display the configured packet forwarding mode.	display ip def cpu	

19.2.4 Creating VLAN Interfaces for Common VLANs

A VLAN interface needs to be configured for each VLAN that performs L3 forwarding or the VLAN needs to be added to the superVLAN.

Operation	Command	Remarks
Enter the global configuration mode.	system-view	
Create a VLAN interface with the VLAN ID being vid and enter the VLAN interface configuration mode.	interface vlan-interface vid	
Return to the global configuration mode.	quit	

Delete the VLAN interface with the VLAN ID being vid .	undo interface vlan-interface vid	
---	--	--

19.2.5 Creating SuperVLAN Interfaces and Adding VLANs to the SuperVLAN

SuperVLAN interfaces are used for communication between hosts in different VLANs in the same network segment. SuperVLAN interfaces are implemented through the ARP proxy.

Operation	Command	Remarks
Enter the global configuration mode.	system-view	
Create a superVLAN interface with the interface ID being vid and enter the superVLAN interface configuration mode.	interface supervlan-interface vid	
Return to the global configuration mode.	quit	
Delete the superVLAN interface with the interface ID being vid .	undo interface supervlan-interface vid	
Configure sub VLANs for the superVLAN interface.	subvlan vid	
Delete the sub VLANs configured for	undo subvlan vid	

the superVLAN interface.		
--------------------------	--	--

19.2.6 Configure IP Addresses for VLAN or SuperVLAN Interfaces

Each VLAN or superVLAN interface can be configured with a maximum of 32 IP addresses and the IP addresses of VLAN or superVLAN interfaces cannot be in the same network segment. The first IP address of an interface will be automatically selected as the primary IP address. When the primary IP address is deleted, the interface automatically selects another IP address as the primary IP address or a configured IP address can be manually specified as the primary IP address. For example, if the IP address of VLAN interface 1 is 10.11.0.1/16, the IP addresses of other interfaces must not be in the 10.11.0.0/16 network segment (such as 10.11.1.1/24).

Operation	Command	Remarks
Enter the global configuration mode.	system-view	
Enter the VLAN or superVLAN interface configuration mode.	interface vlan-interface <i>vid</i> interface supervlan-interface <i>vid</i>	
Configure an IP address and a mask for the interface.	ip address <i>ipaddress ipaddress mask</i>	
Delete all IP addresses of the interface.	undo ip address	
Delete the specified IP address of	undo ip address <i>ipaddress ipaddress mask</i>	

the interface.		
Configure the primary IP address for the interface.	ip address primary <i>ipaddress</i>	

19.2.7 Configure an IP Address Range for VLAN or SuperVLAN Interfaces

Each VLAN or superVLAN interface can be configured with a maximum of eight IP address ranges. After an IP address range is configured, only the ARP entries within this range can be learnt so as to restrict user access. When a VLAN or superVLAN interface is deleted, relevant configurations are automatically deleted.

For superVLAN interfaces, sub VLANs can be specified at the same time so that the set address range is applicable only to these sub VLANs.

Operation	Command	Remarks
Enter the global configuration mode.	system-view	
Enter the VLAN or superVLAN interface configuration mode.	interface vlan-interface <i>vid</i> interface supervlan-interface <i>vid</i>	
Configure the IP address range supported by this interface, ranging from startip to endip .	ip address range <i>startip endip</i>	
Delete all IP address ranges	undo ip address range	

supported by the interface.		
Delete the specified IP address ranges supported by the interface.	undo ip address range <i>startip endip</i>	
Configure the IP address range for sub VLANs of the superVLAN.	ip address range <i>startip endip vlan vlanid</i>	
Delete the IP address ranges of the sub VLANs of the superVLAN.	undo ip address range <i>startip endip vlan vlanid</i>	

19.2.8 Configure the ARP Proxy

ARP request packets are broadcast packets and cannot pass through VLANs. If the ARP proxy function is enabled, ARP interaction is supported between hosts in sub VLANs of the same superVLAN. When the ARP proxy is disabled, the hosts of the sub VLANs in the superVLAN interface cannot communicate with each other.

By default, the ARP request packets from all sub VLANs are processed in the preceding manner. In addition, relevant commands can be used to prevent the ARP request packets from a sub VLAN from being broadcast to other sub VLANs when they are processed by the ARP proxy.

Operation	Command	Remarks
Enter the VLAN configuration mode.	interface vlan-interface <i>vlan-id</i>	
Enable the arp-proxy function for the	local-arp-proxy	

VLAN.		
Disable the arp-proxy function for the VLAN.	undo local-arp-proxy	
Enable the arp-proxy broadcast function for the VLAN.	local-arp-proxy broadcast	
Disable the arp-proxy broadcast function for the VLAN.	undo local-arp-proxy broadcast	
Display the information about the ARP proxy configured in the system.	display local-arp-proxy	
Display information about the ARP proxy broadcast function configured in the system.	display local-arp-proxy broadcast	

19.2.9 Display VLAN and SuperVLAN Interface Information

The L3 GPON integrates VLAN interface information and superVLAN interface information. They can be viewed by running a unified display command.

Operation	Command	Remarks
Display information about the VLAN and superVLAN interfaces currently configured in the system.	display ip interface [[vlan-interface <i>vlanid</i>] [supervlan-interface <i>supervlanid</i>]]	

19.2.10 Configure URPF

URPF aims to prevent network attack behaviors based on source address spoofing. URPF obtains the source address and ingress interface of a packet and uses the source address as the destination address to query the routing table for the matching route. The packet is forwarded if it meets conditions and discarded if it does not meet conditions. Two URPF modes are supported:

Strict mode: In this mode, the source address must exist in the routing table and the egress interface of the source address of the packet is the same as the ingress interface of the packet.

Loose mode: In this mode, the system only checks whether the source address of the packet exists in the unicast routing table. If yes, the packet is forwarded.

Operation	Command	Remarks
Enter the global configuration mode.	system-view	
Enter the VLAN or superVLAN interface configuration mode.	interface vlan-interface <i>vid</i> interface supervlan-interface <i>vid</i>	
Enable URPF for this interface and specify the URPF mode.	urpf { loose strict }	
Disable URPF for this interface.	undo urpf	
Display URPF information in the system.	display urpf	

19.2.11 Disabling the Function of Sending ICMP Packets with an

Unreachable Destination Host on Interfaces

To avoid attacks from address scanning software similar to ip-scan, users can disable the function of sending ICMP packets with an unreachable host on interfaces.

Operation	Command	Remarks
Enter the global configuration mode.	system-view	
Enter the VLAN or superVLAN interface configuration mode.	interface vlan-interface <i>vid</i> interface supervlan-interface <i>vid</i>	
Enable the function of this interface for sending ICMP packets with an unreachable destination	ip icmp unreachable	
Disable the function of this interface for sending ICMP packets with an unreachable destination	undo ip icmp unreachable	
Display the configuration of the function of sending ICMP packets with an unreachable destination	display ip icmp unreachable	

Chapter 20 ARP

20.1 ARP Overview

Address Resolution Protocol (ARP) is used to resolve an IP address into a data link layer address.

An IP address is the address of a host at the network layer. To send a network layer packet to a destination host, the device must know the data link layer address (such as the MAC address) of the destination host. To this end, the IP address must be resolved into the corresponding data link layer address.

Unless otherwise stated, the data link layer addresses that appear in this chapter refer to the 48-bit Ethernet MAC addresses.

20.2 Configure ARP

20.2.1 ARP Configuration List

Configuration Task	Description	Detailed Configuration
Add/Delete ARP	Required	20.2.2
Bind dynamic arp to static	Optional	20.2.3
Display ARP entry	Optional	20.2.4

Configure ARP aging-time	Optional	20.2.5
--------------------------	----------	--------

20.2.2 Add/Delete ARP

Operation	Command	Remarks
Enter global configuration mode	system-view	
Add ARP	arp <i>ip-address</i> mac <i>mac-address</i> vid <i>vlan-id</i> port <i>interface-num</i>	
Delete ARP	undo arp { all static dynamic <i>ip-address</i> }	

20.2.3 Bind dynamic Arp to Static

Operation	Command	Remarks
Enter global configuration mode	system-view	
Bind dynamic arp	arp bind dynamic { <i>ip-address</i> all }	

20.2.4 Display ARP Entry

Operation	Command	Remarks
Display arp entry	display arp { all static dynamic <i>ip-address</i> interface { vlan-interface <i>vlan-id</i> supervlan-interface <i>vlan-id</i> } }	

20.2.5 Configure ARP Aging-time

Operation	Command	Remarks
-----------	---------	---------

Enter global configuration mode	system-view	
Configure ARP aging-time	arp aging-time <i>aging-time</i>	
Configure default ARP aging-time	undo arp aging-time	20minutes by default
Display arp aging-time	display arp aging-time	

Chapter 21 ARP Spoofing and Flood

21.1 ARP Spoofing and Flood Attack Overview

ARP provides no security mechanism and thus is prone to network attacks. An attacker can construct and send ARP packets, thus threatening network security.

A forged ARP packet has the following characteristics:

- The sender MAC address or target MAC address in the ARP message is inconsistent with the source MAC or destination MAC address in the Ethernet frame.
- The mapping between the sender IP address and the sender MAC address in the forged ARP message is not the true IP-to-MAC address binding of a valid client.

ARP attacks bring many malicious effects. Network communications become unstable, users cannot access the Internet, and serious industrial accidents may even occur. ARP attacks may also intercept accounts and passwords of services such as games, network banks, and file services.

ARP spoofing attacks to protection, the key is to identify and prohibit forwarding spoofed ARP packets. From the principle of ARP spoofing, we can see, to prevent ARP spoofing attack requires two ways, first to prevent the virus disguised as the gateway host, it will cause the entire segment of the user can not access; followed by preventing the virus from the host masquerade as another host, eavesdropping data or cause the same network segment can't

communicate between the individual host.

GPONes provide active defense ARP spoofing function, in practical applications, the network hosts the first communication, the GPON will record the ARP table entries, entries in the message of the sender IP, MAC, VID and port correspondence.

To prevent the above mentioned ARP attacks, the GPONes launches a comprehensive ARP attack protection solution.

An access GPON is a critical point to prevent ARP attacks, as ARP attacks generally arise from the host side. To prevent ARP attacks, the access GPONes must be able to

- Establish correct ARP entries, detect and filter out forged ARP packets, and ensure the validity of ARP packets it forwards
- Suppress the burst impact of ARP packets.

After Configure the access GPONes properly, you do not need to deploy ARP attack protection configuration on the gateway. This relieves the burden from the gateway.

If the access GPONes do not support ARP attack protection, or the hosts are connected to a gateway directly, the gateway must be configured to

- Create correct ARP entries and prevent them from being modified.
- Suppress the burst impact of ARP packets or the IP packets that will trigger sending of ARP requests.

The merits of Configure ARP attack protection on the gateway are that this gateway configuration hardly affects the GPONes and can properly support the existing network, thus effectively protecting user investment.

21.1.1 ARP against ARP Flood

Flood attacks are based on the principle of the general flow of a large number of attack packets in the network equipment such as routers, GPONes, and servers, leading to depletion of network equipment, leaving the CPU down the network.

Flood attacks are based on the principle of the general flow of a large number of attack packets in the network equipment such as routers, GPONes and servers, leading to depletion of network equipment, leaving the CPU down the network.

ARP flood attack is aimed mainly at the impact of network device's CPU, the core CPU resources leading to depletion. To defend this type of attack, the GPON must determine in advance and to prohibit flood packet forwarding.

GPONes 's ARP anti-flood function to identify each ARP traffic, according to the ARP rate setting security thresholds to determine whether the ARP flood attack, when a host's ARP traffic exceeds a set threshold, the GPON will be considered a flood attack , immediately pulled into the black host of the virus, banned from the host and all packet forwarding.

In order to facilitate the management of the network administrator to maintain, the GPONes, while the automatic protection will be saved in the system log related to alarms. For disabled users, administrators can set automatic or manual recovery.

GPONes on the entire process is as follows:

- Enable ARP anti-flood function will be broadcast ARP packets received on the CPU, according to an ARP packet source MAC address to identify the different streams.

- Set security ARP rate, if the rate exceeds the threshold, the GPON that is ARP attack.
- If you select the above command deny-all, when an ARP traffic exceeds the threshold set, the GPON will determine the source MAC address, the MAC address to the black hole list of addresses to ban this address to forward all subsequent messages.
- If you select the above command deny-arp, ARP traffic when more than a set threshold, the GPON will be judged based on the source MAC address, the address against all subsequent handling of ARP packets.

For recovery to be disabled in the user's forwarding, administrators can set up automatic or manual recovery recovery time in two ways.

21.2 Configure ARP Anti-Spoofing

21.2.1 ARP Anti-Spoofing Configuration List

Configuration Task	Description	Detailed Configuration
Configure Anti-Spoofing	Required	21.2.2
Configure ARP Packet Source MAC Address Consistency Check	Required	21.2.3
Configure Anti-Gateway-Spoofing	Required	21.2.4

21.2.2 Configure Anti-Spoofing

Operation	Command	Remarks
-----------	---------	---------

Enter global configuration mode	system-view	
Enable ARP anti-spoofing	arp anti-spoofing	
Configure the method of unknown static ARP packet	arp anti-spoofing unknown { discard flood }	

21.2.3 Configure ARP Packet Source MAC Address Consistency Check

Operation	Command	Remarks
Enter global configuration mode	system-view	
Configure ARP Packet Source MAC Address Consistency Check	arp anti-spoofing valid-check	
validation operation	display arp anti-spoofing	

21.2.4 Configure Anti-Gateway-Spoofing

Operation	Command	Remarks
Enter global configuration mode	system-view	
Enable arp anti-spoofing	arp anti-spoofing	
Enable anti-gateway-spoofing	arp anti-spoofing deny-disguiser	
Disable anti-gateway-spoofing	undo arp anti-spoofing deny-disguiser	

21.3 Configure against ARP Flood

21.3.1 ARP against ARP Flood Configuration List

Configuration Task	Description	Detailed Configuration
Configure against ARP Flood	Required	21.3.2
Display and Maintain against ARP Flood	Required	21.3.3

21.3.2 Configure against ARP Flood

Operation	Command	Remarks
Enter global configuration mode	system-view	
Enable ARP flooding	arp anti-flood	
Configure safety trigger threshold	arp anti-flood threshold <i>threshold</i>	
Configure approach for the attacker	arp anti-flood action { deny-arp deny-all } threshold <i>threshold</i>	
Configure automatically banned user recovery time	arp anti-flood recover-time <i>time</i>	
Banned user manual resume forwarding..	arp anti-flood recover { <i>H:H:H:H:H:H</i> all }	

21.3.3 Display and Maintain Against ARP Flood

Operation	Command	Remarks
Display ARP anti-flood configuration and attackers list	display arp anti-flood	

Chapter 22 DHCP-Relay

22.1 DHCP-Relay Overview

Since the packets are broadcasted in the process of obtaining IP addresses, DHCP is only applicable to the situation that DHCP clients and DHCP servers are in the same network segment, that is, you need to deploy at least one DHCP server for each network segment, which is far from economical.

DHCP Relay is designed to address this problem. It enables DHCP clients in a subnet to communicate with the DHCP server in another subnet so that the DHCP clients can obtain IP addresses. In this case, the DHCP clients in multiple networks can use the same DHCP server, which can decrease your cost and provide a centralized administration.

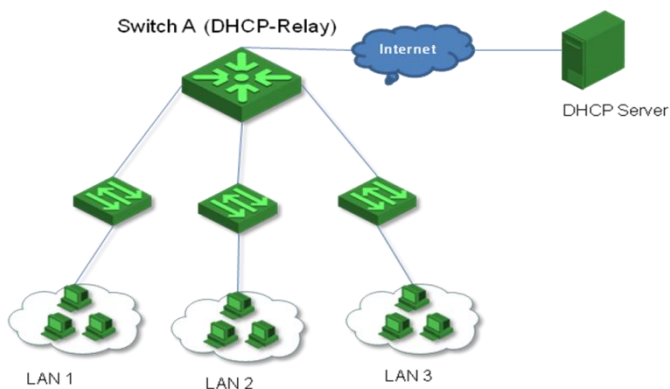

- Typical DHCP relay application

DHCP relays can transparently transmit broadcast packets on DHCP clients or servers to the

DHCP servers or clients in other network segments.

In the process of dynamic IP address assignment through the DHCP relay, the DHCP client and DHCP server interoperate with each other in a similar way as they do without the DHCP relay. The following sections only describe the forwarding process of the DHCP relay.

The DHCP client broadcasts the DHCP-DISCOVER packet.

After receiving the packets, the network device providing the DHCP relay function unicasts the packet to the designated DHCP server based on the configuration.

The DHCP server assigns IP addresses, and then broadcasts the configuration information to the client through the DHCP relay. The sending mode is determined by the flag in the DHCP-DISCOVER packets from the client.

22.2 Configure DHCP-Relay

22.2.1 DHCP-Relay Configuration List

Configuration Task	Description	Detailed Configuration
Configure DHCP Server Group	Required	22.2.2
Configure DHCP Relay to Support Option60	Optional	22.2.3
Enable the DHCP Relay Function	Required	22.2.4
Configure DHCP Option82	Optional	22.2.5

22.2.2 Configure DHCP Server Group

To improve reliability, you can set up multiple DHCP servers in a network. Each DHCP server corresponds to a DHCP server group. After a VLAN or super-VLAN interface references a DHCP server group, it forwards the DHCP packets from the client to all the servers in the server group.

Operation	Command	Remarks
Enter global configuration mode	system-view	
Configure the DHCP server group	dhcp-server <i>group-id</i> ip <i>server-ip</i>	
Enter VLAN interface configuration mode	dhcp-server <i>group-id</i> ip <i>server-ip</i>	
Configure the DHCP server group referenced by the interface	interface vlan-interface <i>vid</i> or interface supervlan-interface <i>super-vid</i>	
Configure the DHCP server group	dhcp-server <i>group-id</i>	

22.2.3 Configure DHCP Relay to Support Option60

DHCP relay supports the processing of DHCP packets with option 60 option fields. On the VLAN interfaces or super VLAN configuration option 60 options, when the interface receives a

DHCP packet from the client, if the option60 option field is included in the packet, it will be matched with the value configured on this interface.

If a match is found, the gateway uses the gateway address in the match to relay the packet and forwards the DHCP packet to the server address in the match.

If no match is found, relay processing is performed according to the requested IP address or the client's IP address.

Operation	Command	Remarks
Enter global configuration mode	system-view	
Enter VLAN interface configuration mode	interface vlan-interface <i>vid</i> or interface supervlan-interface <i>super-vid</i>	
Configure option 60 of the interface	dhcp option60 { equals starts-with } { ascii string hexadecimal hexdata } gateway <i>A.B.C.D</i> [dhcp-server <i>group-id</i>] [server-reply { ascii string hexadecimal hexdata }]	

22.2.4 Enable the DHCP Relay Function

If the DHCP server and the DHCP client are not on the same subnet or the device is configured as a DHCP server, you need to enable the DHCP relay function.

Sometimes, for network security considerations, network administrators do not want the DHCP client to know the address of the DHCP server. In order to meet such requirements, a device that enables a DHCP relay can be configured to hide the address of a real DHCP server. In

this way, the DHCP client regards the device which enables the DHCP relay as a DHCP server to hide the real DHCP server. Of course, if the device that enables the DHCP relay is also a DHCP server, this function is no longer applicable.

Operation	Command	Remarks
Enter global configuration mode	system-view	
Enable global DHCP relay	dhcp-relay	
Hide the IP of the real DHCP Server	dhcp-relay hide server-ip	
Configure the maximum number of hops for DHCP messages	dhcp max-hops <i>hops</i>	

22.2.5 Configure DHCP Option82

The DHCP Option 82 function must be used together with DHCP relay or DHCP snooping.

After the DHCP message received by the GPON already has the Option 82 field, the following three policies are supported:

drop: Drop all DHCP packets that carry the Option 82 field.

keep: Keep Option 82 and forward it.

replace: Replace the existing Option 82 in the packet with the new option82 and forward it according to the actual situation in the local area.

Operation	Command	Remarks
Enter global configuration mode	system-view	
Enable DHCP Option82	dhcp option82	
Configure the DHCP option82 format	dhcp option82 format { normal verbose henan }	
Configure the node-identifier when the DHCP option82 format is verbose	dhcp option82 format verbose node-identifier { mac hostname user-defined node-id }	
Enter port configuration mode	interface ethernet port-id	
Configure the GPON to process DHCP packets that carry the Option 82 field	dhcp option82 strategy { drop keep replace append { hostname hostname-ip } }	
Configure the circuit-id of DHCP option82	dhcp option82 circuit-id string id	

Configure Remote Option for DHCP Option82	dhcp option82 remote-id string { <i>string</i> hostname }	
Display DHCP option82 configuration	display dhcp option82	

Chapter 23 DHCP Snooping

23.1 DHCP Snooping Overview

For the sake of security, the IP addresses used by online DHCP clients need to be tracked for the administrator to verify the corresponding relationship between the IP addresses the DHCP clients obtained from DHCP servers and the MAC addresses of the DHCP clients. GPONes can track DHCP client IP addresses through the DHCP snooping function, which monitors DHCP broadcast packets.

DHCP snooping monitors the following two types of packets to retrieve the IP addresses the DHCP clients obtain from DHCP servers and the MAC addresses of the DHCP clients:

DHCP-ACK packet

DHCP-REQUEST packet

When an unauthorized DHCP server exists in the network, a DHCP client may obtain an illegal IP address. To ensure that the DHCP clients obtain IP addresses from valid DHCP servers, you can specify a port to be a trust port or an untrusted port by the DHCP snooping function:

Trusted ports can be used to connect DHCP servers or ports of other GPONes. Untrusted ports can be used to connect DHCP clients or networks.

Untrusted ports drop the DHCP-ACK and DHCP-OFFER packets received from DHCP servers. Trusted ports forward any received DHCP packets to ensure that DHCP clients can obtain IP addresses from valid DHCP servers.

Trusted vlan: untrusted port will not drop the DHCP-ACK and DHCP-Offer.

23.2 Configure DHCP Snooping

23.2.1 DHCP Snooping Configuration List

Configuration Task	Description	Detailed Configuration
Enable DHCP Snooping	Required	23.2.2
Configure DHCP Snooping Trust port	Required	23.2.3
Configure Max Clients Number	Optional	23.2.4
Configure Link-Down Operation	Optional	23.2.5
Configure IP-Source-Guard	Optional	23.2.6
DHCP Snooping Display and Maintenance	Optional	23.2.7

23.2.2 Enable DHCP Snooping

Operation	Command	Remarks
Enter global configuration mode	system-view	
Enable DHCP Snooping	dhcp-snooping	

Disable DHCP Snooping	undo dhcp-snooping	Disabled by default
-----------------------	---------------------------	---------------------

23.2.3 Configure DHCP Snooping Trust port

Operation	Command	Remarks
Enter global configuration mode	system-view	
Enable interface mode	interface ethernet <i>interface-num</i>	
Configure trust port	dhcp-snooping trust	
Delete trust port	undo dhcp-snooping trust	

23.2.4 Configure Max Clients Number

If the attacker exists, it will disguise as multiple users to ask DHCP Server for address to use up the Server allocable address. As a consequence, Server has no address to allocate to the user who needs the IP address. For this problem, network administrator can take the following measures:

Restrict the DHCP-Client number connected to GPON port. In this case, only the clients connected to the same port with the attacker will suffer the attack.

Restrict the DHCP-Client number in specified VLAN. In this case, only the clients in the same VLAN with the attacker will suffer the attack.

Operation	Command	Remarks
Enter global configuration mode	system-view	

Enable interface mode	interface ethernet <i>interface-num</i>	
Configure max DHCP-Client number connected to GPON port	dhcp-snooping max-clients <i>num</i>	
Enter vlan configuration mode	vlan <i>vlan-id</i>	
Configure max DHCP-Client number in specified VLAN	dhcp-snooping max-clients <i>num</i>	

23.2.5 Configure Link-Down Operation

When the link is down, you can perform the following actions on the dynamic entries which Dhcp-snooping has learned:

enable fast-remove to delete Dhcp-snooping dynamic entries immediately when the port is down.

disable fast-remove to normally age the dynamic entries according to the tenancy term instead of deleting the Dhcp-snooping dynamic entries immediately when the port is down.

Operation	Command	Remarks
Enter global configuration mode	system-view	
Configure link-down operation of the	dhcp-snooping port-down-action	

port	fast-remove	
Delete link-down operation of the port	undo dhcp-snooping port-down-action fast-remove	

23.2.6 Configure IP-Source-Guard

IP Source Guard provides source IP address filtering on a Layer 2 port to prevent a malicious host from impersonating a legitimate host by assuming the legitimate host's IP address. The feature uses dynamic DHCP snooping and static IP source binding to match IP addresses to hosts on untrusted Layer 2 access ports. When using IP-Source-Guard, pay attention:

DHCP-Snooping has been enabled

Use this function in Trust port

After enabling IP-Source-Guard, all traffic with that IP source address is permitted from that trusted client. Traffic from other hosts is denied. This filtering limits a host's ability to attack the network by claiming a neighbor host's IP address. The filtering info can be source MAC, source IP and source port number.

Operation	Command	Remarks
Enter global configuration mode	system-view	-
Configure IP-source-guard bind table	ip-source-guardbind { ip ip-address mac mac-address interface ethernet interface-num }	-
Enter interface configuration mode	interface ethernet interface-num	-
Enable IP-Source-Guard on Trust port	ip-source-guard	By default, ip-source-guard

		on port is disabled.
--	--	----------------------

23.2.7 DHCP Snooping Display and Maintenance

Operation	Command	Remarks
Display DHCP-Snooping clients	display dhcp-snooping clients	
Display DHCP-Snooping status in interface	display dhcp-snooping interface [<i>ethernet interface-num</i>]	
Display DHCP-Snooping status in VLAN	display dhcp-snooping vlan	
Display IP-Source-Guard status in interface	display ip-source-guard	
Display source IP binding table of IP-Source-Guard	display ip-source-guard bind [<i>ip ip-address</i>]	

Chapter 24 DHCP-Server

24.1 DHCP-Server Overview

In the following cases, the DHCP server is usually used to complete the IP address allocation:

Due to the large scale of the network, manual configuration requires a lot of work and it is difficult to centrally manage the entire network.

Since the number of hosts in the network is larger than the number of IP addresses supported by the network, it is impossible to allocate a fixed IP address to each host. Moreover, there are also restrictions on the number of users accessing the network(for example, service providers of Internet access). Therefore, a large number of users must obtain their own IP address through the DHCP.

Only a few hosts on the network need fixed IP addresses. Most hosts do not have a fixed IP address.

24.2 Configure DHCP-Server

24.2.1 DHCP-Server Configuration List

Configuration Task	Description	Detailed Configuration
Configure IP pool	Required	24.2.2

Configure IP Pool Gateway	Required	24.2.3
Configure IP Pool Range	Optional	24.2.4
Enable/Disable IP Address	Optional	24.2.5
Configure IP Pool Lease	Optional	24.2.6
Configure the DHCP Server to Allocate the DNS Server Address	Optional	24.2.7
Configure the DHCP Server to Assign WINS server Addresses	Optional	24.2.8
Display IP Pool configuration	Optional	24.2.9
Configure dhcp-client bind	Optional	24.2.10

24.2.2 Configure IP Pool

Operation	Command	Remarks
Enter global configuration mode	system-view	
Enter IP pool configuration mode	ip pool <i>ippoolname</i>	
Delete IP Pool	undo ip pool <i>ippoolname</i>	

24.2.3 Configure IP Pool Gateway

Operation	Command	Remarks
-----------	---------	---------

Enter global configuration mode	system-view	
Enter ip pool configuration mode	ip pool <i>ippoolname</i>	
Configure gateway	gateway <i>ip-address mask</i>	

24.2.4 Configure IP Pool Range

Operation	Command	Remarks
Enter global configuration mode	system-view	
Enter IP pool configuration mode	ip pool <i>ippoolname</i>	
Configure IP pool range	section <i>section-id from-ip to-ip</i>	
Delete IP pool range	undo section <i>section-id</i>	

24.2.5 Enable/Disable IP Address

Operation	Command	Remarks
Enter global configuration mode	system-view	
enter IP pool configuration mode	ip pool <i>ippoolname</i>	
Enable/disable IP address	ip { disable enable } <i>ip-address</i>	

24.2.6 Configure IP Pool Lease

Operation	Command	Remarks
Enter global configuration mode	system-view	
Enter IP pool configuration mode	ip pool <i>ippoolname</i>	
Configure IP Pool Lease	lease <i>day:hour:min</i>	

24.2.7 Configure the DNS Server Address of DHCP Server

Operation	Command	Remarks
Enter global configuration mode	system-view	
Enter IP pool configuration mode	ip pool <i>ippoolname</i>	
Configure the DNS server address	dns { primary-ip second-ip third-ip fourth-ip } <i>ip-address</i>	
Delete the DNS server address assigned for the DHCP client	undo dns { primary-ip second-ip third-ip fourth-ip }	
Configure the domain name	dns suffix <i>suffix-name</i>	
Delete the domain name	undo dns suffix	

24.2.8 Configure the DHCP Server to Assign WINS Server Addresses

Operation	Command	Remarks
Enter global configuration mode	system-view	
Enter IP pool configuration mode	ip pool <i>ippoolname</i>	
Configure the WINS server address	wins { primary-ip second-ip } <i>ip-address</i>	
Delete the WINS server address	undo wins { primary-ip second-ip }	

24.2.9 Display IP Pool Configuration

Operation	Command	Remarks
Display IP Pool configuration	display ip pool [<i>ippool-name</i> [<i>section-num</i>]]	

24.2.10 Configure Dhcp-client Bind

Some clients (FTP servers, Web servers, etc.) need fixed IP addresses, which can be implemented by binding the MAC address of the client to the IP address. When a client with this MAC address requests an IP address, the DHCP server searches for the corresponding IP address based on the MAC address of the client and assigns that IP address to the client.

Operation	Command	Remarks
Enter global configuration mode	system-view	
Enable dhcp-client bind	dhcp-client bind	
Disable dhcp-client bind	undo dhcp-client bind	
Display dhcp-client bind	display dhcp-client bind	
Add dhcp-client	dhcp-client <i>mac-address</i> <i>ip-address vlan-id username</i>	
Delete dhcp-client	undo dhcp-client { <i>mac-address</i> <i>vlan-id</i> all }	
Display dhcp-client	display dhcp-client [ip	

	<i>ip-address</i>] [mac <i>mac-address</i>]	
--	---	--

Chapter 25 IGMP Snooping

25.1 IGMP Snooping Overview

IGMP (Internet Group Management Protocol) is a part of IP protocol which is used to support and manage the IP multicast between host and multicast router. IP multicast allows transferring IP data to a host collection formed by multicast group. The relationship of multicast group member is dynamic and host can dynamically add or exit this group to reduce network load to the minimum to realize the effective data transmission in network.

IGMP Snooping is used to monitor IGMP packet between host and routers. It can dynamically create, maintain, and delete multicast address table according to the adding and leaving of the group members. At that time, multicast frame can transfer packet according to his own multicast address table.

25.2 IGMP Snooping Configuration

25.2.1 IGMP Snooping Configuration List

Configuration Task	Description	Detailed Configuration
Enable IGMP Snooping	Required	25.2.2
Configure IGMP Snooping Timer	Optional	25.2.3
Configure Port Fast-leave	Optional	25.2.4

Configure Number of Multicast Group Allowed Learning	Optional	25.2.5
Configure IGMP Snooping Querier	Optional	25.2.6
Configure IGMP Snooping Multicast Learning Strategy	Optional	25.2.7
Configure IGMP Snooping Router-Port	Optional	25.2.8
Configure IGMP Snooping Port Multicast VLAN	Optional	25.2.9
Configure Host Port Record MAC Functions	Optional	25.2.10
Configure Port of Dropped Query Packets or Not	Optional	25.2.11
Configure Port of Discarded Packets Report or Not	Optional	25.2.12
Configure multicast preview	Optional	25.2.13
Configure Profile of Black and White List	Optional	25.2.14
Display and Maintenance of IGMP Snooping	Optional	25.2.15

25.2.2 Enable IGMP Snooping

Operation	Command	Remarks
Enter global configuration mode	system-view	

Enable IGMP Snooping	igmp-snooping	igmp-snooping is disabled by default.
Disable IGMP Snooping	undo igmp-snooping	

25.2.3 Configure IGMP Snooping Timer

Operation	Command	Remarks
Enter global configuration mode	system-view	
Configure IGMP Snooping host aging time	igmp-snooping host-aging-time <i>seconds</i>	300s by default
Configure maximum leave time	igmp-snooping max-response-time <i>seconds</i>	10s by default

25.2.4 Configure IGMP-snooping Fast-leave

Under normal circumstances, IGMP-Snooping on IGMP leave message is received directly will not remove the port from the multicast group, but to wait some time before the port from the multicast group.

Enabling quickly delete function, IGMP-Snooping IGMP leave packet received, directly to the port from the multicast group. When the port is only one user, can be quickly removed to save bandwidth.

Operation	Command	Remarks
Enter global configuration mode	system-view	

Enter port configuration mode	interface { { ethernet <i>interface-num</i> } <i>interface-name</i> }	
Configure IGMP-snooping fast-leave	igmp-snooping fast-leave	Disable by default

25.2.5 Configure Number of Multicast Group Allowed Learning

Use `igmp-snooping group-limit` command to configure the number of the multicast group allowed learning.

Operation	Command	Remarks
Enter global configuration mode	system-view	
Enter port configuration mode	interface { { ethernet <i>interface-num</i> } <i>interface-name</i> }	
Configure the number of the multicast group allowed learning	igmp-snooping group-limit <i>number</i>	

25.2.6 Configure IGMP Snooping Querier

In an IP multicast network running IGMP, a multicast router or Layer 3 multicast GPON is responsible for sending IGMP general queries, so that all Layer 3 multicast devices can establish and maintain multicast forwarding entries, thus to forward multicast traffic correctly at the network layer. This router or Layer 3 switch is called IGMP querier.

However, a Layer 2 multicast switch does not support IGMP, and therefore cannot send general queries by default. By enabling IGMP Snooping on a Layer 2 switch in a VLAN where multicast traffic needs to be Layer-2 switched only and no multicast routers are present, the

Layer 2 switch will act as the IGMP Snooping querier to send IGMP queries, thus allowing multicast forwarding entries to be established and maintained at the data link layer.

Operation	Command	Remarks
Enter global configuration mode	system-view	
Configuration is not black and white list in the multicast group to learn the rules of the default	igmp-snooping { permit deny } { group all vlan <i>vlan-id</i> }	By default, not black and white list in the multicast group to learn the rules for the learning of all multicast group
Enter port configuration	interface ethernet <i>interface-num</i>	
Configure the port multicast black list	igmp-snooping { permit deny } group-range <i>multicast-mac-address</i> multi-count <i>num</i> vlan <i>vlan-id</i>	Configure the port to learn (not learn) VID of the start of continuous num mac multicast groups
Configure the port multicast black list	igmp-snooping { permit deny } group <i>multicast-mac-address</i> vlan <i>vlan-id</i>	By default, any multicast group

		are not black and white list are added
--	--	--

25.2.7 Configure IGMP Snooping Multicast Learning Strategy

Configured multicast learning strategies, the administrator can control the router only to learn the specific multicast group. If a multicast group is added to the blacklist, then the router will not learn the multicast group; the contrary, in the white list in the router can learn multicast group.

Operation	Command	Remarks
Enter global configuration mode	system-view	
Open the IGMP-Snooping querier	igmp-snooping querier	
Configure VLAN general query messages	igmp-snooping querier-vlan <i>vlan-id</i>	
Configured to send general query message interval	igmp-snooping query-interval <i>interval</i>	
Configuration is generally the maximum query response time of message	igmp-snooping query-max-respond <i>time</i>	
Configured to send general inquiries packet source IP address	igmp-snooping general-query source-ip <i>ip-address</i>	

25.2.8 Configure IGMP Snooping Router-Port

You can configure the router port will be automatically added to the dynamic IGMP Snooping Multicast learn to make routing port also has a multicast packet forwarding capability.

When the GPON receives a host membership report sent packets, the port will be forwarded to the route.

Operation	Command	Remarks
Enter global configuration mode	system-view	
Configure hybrid routing port	igmp-snooping route-port forward	
Configure dynamic routing port aging time	igmp-snooping router-port-age { on off age-time }	
Configure static routing port	igmp-snooping route-port vlan <i>vlan-id</i> interface { all ethernet <i>interface-num</i> }	

25.2.9 Configure IGMP Snooping Port Multicast VLAN

Multicast VLAN on the port function, regardless of the port receiving the IGMP messages belong to which VLAN, the GPON will be modified as a multicast VLAN.

Operation	Command	Remarks
Enter global configuration mode	system-view	
Enter port configuration mode	interface ethernet <i>interface-num</i>	
Configure IGMP Snooping port multicast VLAN	igmp-snooping multicast vlan <i>vlan-id</i>	

25.2.10 Configure Host Port Record MAC Functions

When this feature is enabled on the port, the GPON will record the source packet IGMP report MAC address.

Operation	Command	Remarks
Enter global configuration mode	system-view	
Enter port configuration mode	interface ethernet <i>interface-num</i>	
Configure the host port record MAC	igmp-snooping record-host	

25.2.11 Configure Port of Dropped Query Packets

When this feature is enabled on a port, the GPON drops the IGMP query message. Default port to receive all IGMP packets.

Operation	Command	Remarks
Enter global configuration mode	system-view	
Enter port configuration mode	interface ethernet <i>interface-num</i>	
Discard the query message to the configuration port	igmp-snooping drop query	
Configure the port to receive the query message	undo igmp-snooping drop query	

25.2.12 Configure Port of Discarded Report Packets

When this feature is enabled on a port, the GPON drops the IGMP report message. Default port to receive all IGMP packets.

Operation	Command	Remarks
Enter global configuration mode	system-view	

Enter port configuration mode	interface ethernet <i>interface-num</i>	
Configure the port discarded packets report	igmp-snooping drop report	
Configure the port to receive a report with	undo igmp-snooping drop report	

25.2.13 Configure Multicast Preview

Multicast IGMP Snooping provides preview feature, users can configure the multicast channel preview, you can configure a single multicast length preview, preview interval, duration, and reset to allow preview times.

Operation	Command	Remarks
Enter global configuration mode	system-view	
Configure Multicast preview	igmp-snooping preview	
Configure multicast channel preview	igmp-snooping preview group-ip <i>ip-address</i> vlan <i>vlan-id</i> interface ethernet <i>interface-num</i>	
Configuration when the long single preview, preview interval, duration and allows preview preview reset the number of	igmp-snooping preview { time-once <i>time-once</i> time-interval <i>time-interval</i> time-reset <i>time-reset</i> permit-times <i>preview-times</i> }	

25.2.14 Configure Profile of Black and White List

IGMP Snooping provides the way black and white list feature profile, first in global configuration mode to create a number of profile, then the port configuration mode to configure the port reference profile list. Users can configure the IGMP Snooping profile of the type and scope, which refers to the type of permit / deny, you can use the multicast IP address range or MAC address to configure. IGMP Snooping profile only the port referenced to take effect, the configuration port reference profile, the more the type of profile must be the same between that port can only refer to the same type (permit or deny) the profile. When the port is referenced permit the profile, the profile can only learn the definition of the corresponding multicast group; when the port reference deny the profile, the profile can be defined in addition to learning outside of all multicast group; when the port does not refer to any profile, in accordance with Normally learning multicast group.

Operation	Command	Remarks
Enter global configuration mode	system-view	
Create a profile, and enter profile configuration mode	igmp-snooping profile <i>profile-id</i>	
Configuration profile types	profile limit { permit deny }	
Configuration profile ip range	ip range <i>start-ip end-ip [vlan vlan-id]</i>	
Range of configuration profile mac	mac range <i>start-mac end-mac [vlan vlan-id]</i>	
Enter port configuration mode	interface ethernet <i>interface-num</i>	
Reference configuration profile	igmp-snooping profile refer <i>profile-list</i>	

25.2.15 Display and Maintenance of IGMP Snooping

After completing the above configuration, can use the following command to view configuration.

Operation	Command	Remarks
See the related configuration IGMP Snooping	display igmp-snooping	
See dynamic routing port	display igmp-snooping router-dynamic	
Display static router port configuration	display igmp-snooping router-static	
Display Record in host MAC	display igmp-snooping record-host [interface ethernet <i>interface-num</i>]	
Display information about multicast preview	display igmp-snooping preview	
Display the current state of multicast channel preview	display igmp-snooping preview status	
Display profile configuration information	display igmp-snooping profile [interface ethernet <i>interface-num</i>] [<i>profile-list</i>]	
Display multicast group	display multicast [interface ethernet <i>interface-num</i>]	

Chapter 26 MLD Snooping

26.1 MLD Snooping Overview

MLD (Multicast Listener Discovery) Internet Group Management Protocol is part of the IPv6 protocol, to support and manage hosts and multicast routers IP multicast. IP Multicast allows the transmission of IP packets to a multicast group constitutes a set of host, multicast group membership relationship is dynamic, host can dynamically join or leave the group, so to minimize the network load, effective online data transfer.

MLD Snooping is used to monitor hosts and routers between the MLD messages, according to group members join, leave, and dynamically create, maintain and delete the multicast address table, this time, multicast frames based on their respective multicast address table be forwarded.

26.2 MLD Snooping

26.2.1 MLD Snooping Configuration List

Configuration Task	Description	Detailed Configuration
Start MLD Snooping	Required	26.2.2
Configure MLD Snooping Timer	Optional	26.2.3
Configure Fast-leave Port	Optional	26.2.4

Maximum number of learning multicast configuration port	Optional	26.2.5
Configure MLD-Snooping Multicast Learning Strategies	Optional	26.2.6
Configure MLD-Snooping querier	Optional	26.2.7
Configure Routing port	Optional	26.2.8
Multicast VLAN port configuration	Optional	26.2.9
Display and maintenance of MLD Snooping	Optional	26.2.10

26.2.2 Start MLD Snooping

Operation	Command	Remarks
Enter global configuration mode	system-view	
Start MLD Snooping	mld-snooping	

26.2.3 Configure MLD Snooping Timer

Operation	Command	Remarks
Enter global configuration mode	system-view	
Configure dynamic multicast member port aging time	mld-snooping host-aging-time <i>time</i>	300s by default
Configure the maximum response time to leave	mld-snooping max-response-time <i>time</i>	10s by default

26.2.4 Configure Fast-leave Port

Under normal circumstances, MLD-Snooping in MLD leave message is received directly will not remove the port from the multicast group, but to wait some time before the port from the multicast group.

Start quickly delete function, MLD-Snooping received MLD leave message, the direct port from the multicast group. When the port is only one user, it can be quickly removed to save bandwidth.

Operation	Command	Remarks
Enter global configuration mode	system-view	
Enter port configuration mode	interface ethernet <i>interface-num</i>	
Fast-leave configuration port	mld-snooping fast-leave	

26.2.5 Maximum Number of Learning Multicast Configuration Port

You can use the following command to set up each port can learn the number of multicast.

Operation	Command	Remarks
Enter global configuration mode	system-view	
Enter port configuration mode	interface ethernet <i>interface-num</i>	
Configured port number of the largest study of multicast	mld-snooping group-limit <i>number</i>	By default, the maximum learning of multicast port number NUM_MULTICA

		ST_GROUPS
--	--	-----------

Caution:

NUM_MULTICAST_GROUPS refers to the machine can learn the maximum number of multicast, each product NUM_MULTICAST_GROUPS may be different. Although theoretically a maximum of learning multicast port number NUM_MULTICAST_GROUPS, but also that other ports can learn the number of multicast will be occupied. In other words, all the ports will share this NUM_MULTICAST_GROUPS multicast group resources.

26.2.6 Configure MLD Snooping Multicast Learning Strategies

Configured multicast learning strategies, the administrator can control the router only to learn the specific multicast group. If a multicast group is added to the blacklist, then the router will not learn the multicast group; the contrary, in the white list in the multicast group of routers can be learned.

Operation	Command	Remarks
Enter global configuration mode	system-view	
Configuration is not black and white list in the multicast group to learn the rules of the default	mld-snooping { permit deny } { group all vlan <i>vlan-id</i> }	
Enter port configuration mode	interface ethernet <i>interface-num</i>	
Configure the port multicast black list	mld-snooping { permit deny } group-range <i>multicast-address</i> multi-count	

	<i>num</i> vlan <i>vlan-id</i>	
Configure the port multicast black list	mld-snooping { permit deny } group <i>multicast-address</i> vlan <i>vlan-id</i>	

26.2.7 Configure MLD-Snooping querier

After running the MLD protocol multicast network, there will be a full-time query multicast router or Layer 3 multicast router is responsible for sending MLD query.

However, MLD does not support Layer 2 GPON function, so no way to query device capabilities, universal group can't send query message. Users can configure MLD-Snooping querier, the GPON to the second floor take the initiative in the data link layer to send general queries, messages, in order to establish and maintain multicast forwarding entry.

Users can also configure the MLD Snooping querier sends general query messages with the source address, the maximum response time and query cycle.

Operation	Command	Remarks
Enter global configuration mode	system-view	
On MLD-Snooping querier	mld-snooping querier	
Configured to send general query message interval	mld-snooping query-interval <i>interval</i>	
Configuration is generally the maximum query response time of message	mld-snooping query-max-respond <i>time</i>	

26.2.8 Configure Routing Port

You can configure the router port will be automatically added to the dynamic MLD Snooping Multicast learn to make routing port also has a multicast packet forwarding capability.

When the GPON receives a host membership report sent packets, the port will be forwarded to the route.

Operation	Command	Remarks
Enter global configuration mode	system-view	
Hybrid routing port configuration function	mld-snooping route-port forward	
Configure dynamic routing port aging time	mld-snooping router-port-age { on off <i>age-time</i> }	
Configure static routing port	mld-snooping route-port vlan <i>vlan-id</i> interface { all ethernet <i>interface-num</i> }	

26.2.9 Multicast VLAN Port Configuration

Multicast VLAN on the port function, regardless of the port received MLD messages belong to which VLAN, the GPON will be modified as a multicast VLAN.

Operation	Command	Remarks
Enter global configuration mode	system-view	
Enter port configuration mode	interface ethernet <i>interface-num</i>	
Multicast VLAN port configuration	mld-snooping multicast vlan <i>vlan-id</i>	

26.2.10 Display and Maintenance of MLD Snooping

After completing the above configuration, can use the following command to view configuration.

Operation	Command	Remarks
See related MLD Snooping Configuration	display mld-snooping	
See dynamic routing port	display mld-snooping router-dynamic	
View static router port configuration	display mld-snooping router-static	
View multicast group	display mld-snooping group	

Chapter 27 Static Multicast Table

27.1 Static Multicast Table Overview

In addition to dynamic learning, multicast tables support manually configuration, and a manually configured multicast table is a static multicast table. The static multicast MAC table will not be aged and it cannot be lost after being saved.

At present, only the corresponding multicast entries of ipv4 can be static configured, and ipv6 multicast entries cannot be static configured.

27.2 Configure Static Multicast Table

27.2.1 Static Multicast Group Configuration List

Configuration Task	Description	Detailed Configuration
Create a Static Multicast Group	Required	27.2.2
Add a Port to the Multicast Group	Required	27.2.3
Create a Static Multicast Group based on Group IP	Optional	27.2.4
Display and Maintenance of Static MulticastTable	Optional	27.2.5

27.2.2 Create a Static Multicast Group

Operation	Command	Remarks
-----------	---------	---------

Enter global configuration mode	system-view	
Create a static multicast group	multicast mac-address <i>mac-address</i> vlan <i>vlan-id</i>	
Delete a static multicast group	undo multicast [mac-address <i>mac-address</i> vlan <i>vlan-id</i>]	

The parameter *mac* refers to the mac address of the multicast group. It is required to use the multicast address format, for example: 01: 00: 5e: **: **: **, *ip* refers to multicast ip, for example, 224.0.1.1; *vlan-id* refers to VLAN ID, with the range of 1 to 4094. It must be an existed VLAN. If the added static multicast group belongs to a VLAN that does not exist, the multicast group fails to be added.

27.2.3 Add a Port to the Multicast Group

Operation	Command	Remarks
Enter global configuration mode	system-view	
Add a port to a static multicast group	multicast mac-address <i>mac-address</i> vlan <i>vlan-id</i> interface { all ethernet <i>interface-list</i> }	
Delete a port from static multicast group	undo multicast mac-address <i>mac-address</i> vlan <i>vlan-id</i> interface { all ethernet <i>interface-list</i> }	

27.2.4 Create a Static Multicast Group based on Group IP

Operation	Command	Remarks
Enter global configuration mode	system-view	
Create a static multicast group based on group IP	multicast ip-address <i>ip-address</i> vlan <i>vlan-id</i>	
Delete a static multicast group based group IP	undo multicast ip-address <i>ip-address</i> vlan <i>vlan-id</i>	
Add a port to a static multicast group base on group IP	multicast ip-address <i>ip-address</i> vlan <i>vlan-id</i> interface { all ethernet <i>interface-list</i> }	
Delte a por from static multicast group base on group IP	undo multicast ip-address <i>ip-address</i> vlan <i>vlan-id</i> interface { all ethernet <i>interface-list</i> }	

27.2.5 Display and Maintenance of Static Multicast Table

Operation	Command	Remarks
DisplayStatic MulticastTable by MAC	display multicast mac-address <i>mac-address</i>	
DisplayStatic MulticastTable by IP	display multicast ip-address <i>ip-address</i>	

Chapter 28 IGMP

28.1 IGMP Overview

IGMP (Internet Group Management Protocol) is used to manage IP multicast group member as well as to establish and maintain the relationship between the IP host and multicast router.

Currently, there are three versions of IGMP: IGMPv1 (RFC 1112), IGMPv2 (RFC 2236) and IGMPv3 (RFC 3376). The IGMPv2 version is widely used.

IGMPv1 defines two types of message: General Query and Group Membership Report. It manages the multicast group members based on query mechanism and response mechanism.

IGMPv2 defines three types of message: Membership Query (including General Query and Group-Specific Query), Group Membership Report and Group Membership-Leave. Compared with IGMPV1, IGMPV12 added querier election mechanism and leave group mechanism.

IGMPv3 added source filter mechanism on the basis of v2, enhancing the function of query and report. Moreover, it presents the clear requirements to accept or reject the multicast message from some certain multicast source when the host adds certain multicast group.

All versions support ASM mode. Only IGMPv3 supports SSM mode. IGMPv1 and IGMPv2 can be able to apply to SSM mode under the help of IGMP SSM Mapping technology.

28.2 Configure IGMP

28.2.1 IGMP Configuration List

Configuration Task	Description	Detailed Configuration
Enable Multicast Routing Protocol	Required	28.2.2
Enable IGMP Protocol	Required	28.2.3
Configure IGMP Version	Optional	28.2.4
Configure IGMP General Query Interval	Optional	28.2.5
Configure Last-Member-Query-Interval	Optional	28.2.6
Configure Robustness Variable of IGMP Querier	Optional	28.2.7
Configure the Maximum Number of the Multicast Group Added to the Interface	Optional	28.2.8
Configure IGMP Maximum Query Response Time	Optional	28.2.9
Configure Multicast Group Filter Function	Optional	28.2.10
Establish Static IP Multicast Table	Optional	28.2.11
Configure Static Multicast Group	Optional	28.2.12
Configure IGMP Proxy	Optional	28.2.13
Configure IGMP SSM Mapping	Optional	28.2.14
Configure SSM-Mapping static group address mapping rule	Optional	28.2.15
IGMP Display and Maintenance	Optional	28.2.16

28.2.2 Enable Multicast Routing Protocol

You should enable multicast routing before Configure IGMP protocol. Only if you enable the multicast protocol can relative configurations take effect.

Operation	Command	Remarks
Enter global configuration	system-view	
Enable enable multicast routing	ip multicast-routing	
Disable multicast routing	undo ip multicast-routing	

28.2.3 Enable IGMP Protocol

Enable the IGMP protocol on interface to make GPON forward multicast message. Please perform the configurations under interface configuration mode (including VLAN interface and SuperVlan interface).

Operation	Command	Remarks
Enter global configuration	system-view	
Enter VLAN-interface mode	interface { vlan-interface supervlan-interface } vlan-id	
Enable IGMP protocol	ip igmp	
Disable IGMP protocol	undo ip igmp	

28.2.4 Configure IGMP Version

Due to different versions of the IGMP protocol have different message structures and message types, so you need to configure the same IGMP version for all the routers in the same network segment. Otherwise, IGMP cannot be able to run normally. Please perform the configurations

under interface configuration mode (including VLAN interface and SuperVlan interface).

Operation	Command	Remarks
Enter global configuration	system-view	
Enter VLAN-interface mode	interface { vlan-interface supervlan-interface } vlan-id	
Configure the interface to run IGMP version	ip igmp version { 1 2 3 }	IGMPv2 by default
Configure defaultIGMPversion	undo ip igmp version	

28.2.5 Configure IGMP General Query Interval

The Ethernet GPON periodically sends the Membership Query Message to discover which multicast groups exist on the network connected to the Ethernet GPON. This time interval is set by the Query Interval timer. You can configure the Query Interval timer to modify the interval at which IGMP hosts send query messages.

Operation	Command	Remarks
Enter global configuration	system-view	
Enter VLAN-interface mode	interface { vlan-interface supervlan-interface } vlan-id	
Configure IGMP general query interval	ip igmp query-interval seconds	125 seconds by default.
Configure default IGMP general query interval	undo ip igmp query-interval	

28.2.6 Configure Last-Member-Query-Interval

After receiving leave-message, GPON will forward specified group query message to know whether there are other group members in multicast group. User can be able to modify the interval value of specified group query message.

Operation	Command	Remarks
Enter global configuration	system-view	
Enter VLAN-interface mode	interface { vlan-interface supervlan-interface } vlan-id	
Configure last-member-query-interval	ip igmp last-member-query-interval <i>seconds</i>	1 second by default.
Configure default last-member-query-interval	undo ip igmp last-member-query-interval	

28.2.7 Configure Robustness Variable of IGMP Querier

The robustness variable is a very important parameter that reflects the performance of the IGMP protocol running on the GPON. It is mainly used to control message forwarding frequency so as to enhance the robustness of network protocol operation. In addition, the robustness variable coefficient is also an important parameter for calculating other variables, such as the existence time of other inquires, group membership time, etc.

Operation	Command	Remarks
Enter global configuration	system-view	

Enter VLAN-interface mode	interface { vlan-interface supervlan-interface } <i>vlan-id</i>	
Configure robustness variable of IGMP querier	ip igmp robustness-variable <i>value</i>	2 by default.
Configure default robustness variable of IGMP querier	undo ip igmp robustness-variable	

28.2.8 Configure the Maximum Number of the Multicast Group Added to the Interface

Through this function, users can easily control the number of multicast groups that an interface can join. If the maximum number is exceeded, the GPON will not process the newly added IGMP messages.

Operation	Command	Remarks
Enter global configuration	system-view	
Enter VLAN-interface mode	interface { vlan-interface supervlan-interface } <i>vlan-id</i>	
Configure the maximum number of the multicast group added to the interface	ip igmp limit-group <i>limit-num</i>	By default, the maximum number of IGMP groups added to an interface is the maximum

		number of multicast groups
Configure the default maximum number of the multicast group added to the interface	undo ip igmp limit-group	

28.2.9 Configure IGMP Maximum Query Response Time

When the host receives the query from the GPON, it will start the Delay Timers for each multicast group it joins. It uses a random number between 0 and Max Response Time as the initial value. The Max Response Time is the maximum response time specified by the query message (the maximum query response time for IGMP Version 1 is 10 seconds). The host should inform GPON the member of the multicast group before the timer expired. If the GPON does not receive any group member reports after the maximum query response time has expired, it considers that there is no local group member and it will not send the multicast packets it receives to the network to which it is connected.

Operation	Command	Remarks
Enter global configuration	system-view	
Enter VLAN-interface mode	interface { vlan-interface supervlan-interface } vlan-id	
Configure the maximum query response time of IGMP	ip igmp query-max-response-time seconds	10 seconds by default
Configure the default maximum	undo ip igmp query-max-response-time	

query response time of IGMP		
-----------------------------	--	--

28.2.10 Configure Multicast Group Filter Function

The GPON determines which multicast group includes the local group members that are directly connected to the GPON by sending an IGMP query message. If you do not want to add certain multicast groups to a host on the network segment where the interface is located, you can configure the ACL rule on the interface. The interface filters the received IGMP report according to the rule. The multicast group maintains the group membership.

Operation	Command	Remarks
Enter global configuration	system-view	
Enter VLAN-interface mode	interface { vlan-interface supervlan-interface } <i>vlan-id</i>	
Configure filter function of multicast group	ip igmp access-group acl-number [all ethernet interface-list]	By default, hosts on this interface can join any valid multicast group.
Delete filter function of multicast group	undo ip igmp access-group acl-number [all ethernet interface-list]	

28.2.11 Establish Static IP Multicast Table

Create a static IP multicast entry to realize the forwarding of multicast message. You can create (S, G) and (*, G) entries. If a static multicast member exists (which is created through

the command of ip igmp static-group), It will automatically add the static member's port to the egress port of the corresponding static entry.

Operation	Command	Remarks
Enter global configuration	system-view	
Enter VLAN-interface mode	interface { vlan-interface supervlan-interface } vlan-id	
Create static IP multicast table	ip igmp create-group groups-address-list source { * source-address }	There is no static multicast table by default.
Delete static IP multicast table	undo ip igmp create-group groups-address-list source { * source-address }	

28.2.12 Configure Static Multicast Group

Configure the GPON port to become a static multicast group so that the GPON can forward the multicast packets to this port and specify the source address list at the same time. Please perform the configurations under interface configuration mode (including VLAN interface and SuperVlan interface). When Configure this function under the SuperVlan interface mode, you should specify the sub-VLAN.

Operation	Command	Remarks
Enter global configuration	system-view	
Enter VLAN-interface mode	Interface { vlan-interface 	

	supervlan-interface } <i>vlan-id</i>	
Add a port into static multicast group	ip igmp static-group { * <i>groups-address</i> } { all ethernet <i>interface-list</i> } sourcelist { * <i>sourcelist</i> }	
Delete a port from static multicast group	undo ip igmp static-group { all <i>groups-address</i> { all ethernet <i>interface-list</i> } sourcelist { * <i>sourcelist</i> } }	

28.2.13 Configure IGMP Proxy

After enabling IGMP proxy, GPON acts as a host forwards the multicast group information via report message. When the multicast router receives the message, it transmits the multicast traffic to GPON and then GPON will transmit the multicast traffic to the downlink user. If a certain multicast has no host, GPON will forward leave message to multicast routing, and then multicast routing will stop forwarding multicast data to GPON. This function is mainly applied to network peripheral GPONs, which effectively saves GPON resources since GPONs can complete the multicast forwarding without enabling the multicast routing protocols.

Operation	Command	Remarks
Enter global configuration	system-view	
Enter VLAN-interface mode	interface { vlan-interface supervlan-interface } <i>vlan-id</i>	
Enable IGMP-Proxy	igmp-proxy	
Disable IGMP-Proxy	undo igmp-proxy	

28.2.14 Configure IGMP SSM Mapping

In the SSM network, some recipient hosts only run IGMPv1 or IGMPv2 due to the variety of possible restrictions. You can configure the IGMP SSM Mapping function in router so as to offer SSM service to those recipient hosts of IGMPv1 or IGMPv2.

Operation	Command	Remarks
Enter global configuration	system-view	
Enter VLAN-interface mode	interface { vlan-interface supervlan-interface } vlan-id	
Enable ssm-mapping	ip igmp ssm-mapping	
Disable ssm-mapping	undo ip igmp ssm-mapping	

28.2.15 Configure SSM-Mapping static group address mapping rule

Operation	Command	Remarks
Enter global configuration	system-view	
Enter IGMP global configuration mode	mroute igmp	
Configure the SSM-Mapping static group address mapping rule	ssm-mapping ipaddress mask multicast-source-ipaddress	By default, no static group address mapping rule is configured

Delete the SSM-Mapping static group address mapping rule	undo ssm-mapping { <i>ipaddress mask</i> all }	
--	--	--

28.2.16 IGMP Display and Maintenance

Operation	Command	Remarks
Display IGMP interface information	display ip igmp interface [{ vlan-interface <i>vlan-id</i> } { supervlan-interface <i>vlan-id</i> }]	
Display static configurations and the IGMP multicast group information	display ip igmp groups [<i>multicast-ip</i>]	
Display IGMP proxy	display igmp-proxy	
Display SSM-Mapping mapping rule	display ip igmp ssm-mapping [<i>multicast-ip</i>]	

Chapter 29 PIM

29.1 PIM Overview

Protocol Independent Multicast-Dense Mode (PIM-DM) is a dense-mode multicast routing protocol, which is applicable to small-sized networks. In a PIM-DM network, members of a multicast group are densely distributed.

29.1.1 Principles of PIM-DM

The operation of PIM-DM can be understood as neighbor discovery, flooding-prune, and graft.

1) Neighbor discovery

Upon save, a PIM-DM router needs to discover neighbors by sending Hello packets. The relationships between PIM-DM capable network nodes are maintained through exchange of Hello packets. In PIM-DM, Hello packets are sent periodically.

2) Flooding&Prune

PIM-DM assumes that all the hosts on a network are ready to receive multicast data. A packet is transmitted from multicast source S to multicast group G. After receiving this multicast packet, the router performs an RPF check based on the unicast routing table and creates an (S,G) entry if the RPF check is successful. Then the router floods the packet to all the downstream PIM-DM nodes in the network. The router discards the packet if the RPF check fails (the multicast packet is from an incorrect interface). In the

flooding process, an (S,G) entry will be created in the PIM-DM multicast domain.

If no downstream node is a multicast group member, the router sends a Prune message to notify the upstream node that data should not be sent to downstream nodes any more. After receiving the Prune message, the upstream node removes the interface that sends the multicast packet from the outbound interface list matching the (S,G) entry. Eventually, a Shortest Path Tree (SPT) with S as the root is created. The prune process is initiated by a leaf router.

The whole process is called the flooding&prune process. A timeout mechanism is made available on a pruned router so that the router may initiate a flooding&prune process again if the prune process times out. The flooding&prune mechanism of PIM-DM operates periodically over and over again.

In the flooding&prune process, PIM-DM performs RPF check and builds a multicast forwarding tree with the data source as the root based on the current unicast routing tables. When a multicast packet arrives, the router first judges whether the path of the multicast packet is correct. If the interface where the packet arrives is what specified in the unicast route, the path is considered correct. Otherwise, the multicast packet is discarded as a redundant packet and will not be forwarded in multicast mode. The unicast route may be discovered by any unicast routing protocol such as RIP and OSPF instead of a specific routing protocol.

3) Assert

As shown in the following figure, multicast routers A and B are on the same LAN segment and they have their respective paths to multicast source S. After receiving a multicast

packet from S, both of them will forward the packet on the LAN. As a result, the downstream multicast router C will receive two identical multicast packets.

An upstream router uses the Assert mechanism to select the only forwarder. The upstream router sends Assert messages to select the best route. If two or more paths have the same priority and metric value, the router with the largest IP address is selected as the upstream neighbor of the (S,G) entry and is responsible for forwarding the (S,G) multicast packet.

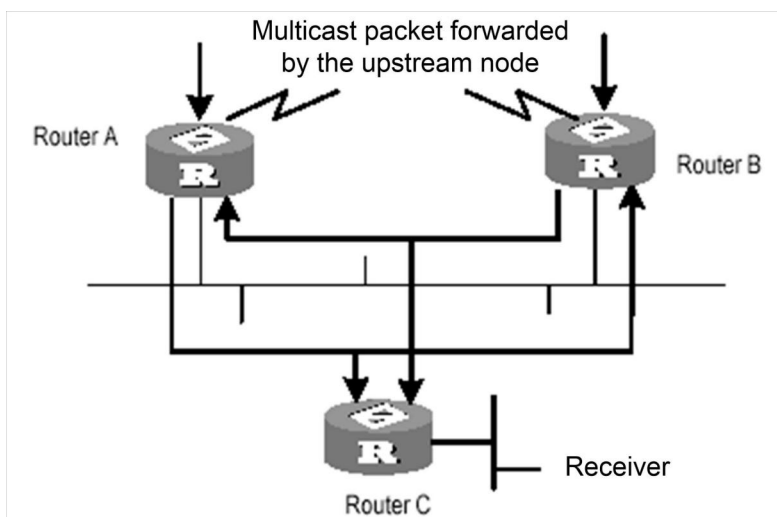

Assert mechanism

4) Graft

When the pruned downstream node needs to enter the forwarding state again, it sends a Graft message to the upstream node. Before Configure the features of IGMP, you must enable the multicast routing function.

5) SRM

To avoid repeated flooding&prune actions, the SRM is added to new protocol standards. The router in direct connection with the multicast source sends state update packets periodically. After receiving a state update packet, the PIM-capable router refreshes the prune state.

29.1.2 Principles of PIM-SM

The operation of Protocol Independent Multicast-Sparse Mode (PIM-SM) can be understood as neighbor discovery, rendezvous point tree (RPT) generation, multicast source registration, and SPT GPON. The neighbor discovery of PIM-SM is the same as that of PIM-DM.

1) RPT generation

When a host joins a multicast group (G), the leaf router which is directly connected with the host if detecting receivers of G by sending IGMP packets, calculates an RP for G and sends a Join message to an upper-level node of the RP for participating in the multicast group. Every router between the leaf router and the RP will generate a (*,G) entry in its forwarding table and therefore they will forward any packets destined for G regardless of where the packets come from. When the RP receives a packet bound for G, the packet will later be sent to the leaf router along the established path and then reach the host. Finally an RPT with the RP as the root is created.

2) Multicast source registration

When multicast source S is sending a multicast packet to multicast group G, the PIM-SM router which is directly connected with S encapsulates the multicast packet into a registration packet and then sends it to an RP in unicast mode. If multiple PIM-SM routers exist on a network

segment, the designated router (DR) sends the multicast packet.

29.1.3 Principles of PIM-SSM

PIM-Source Specific Multicast (PIM-SSM) is dependent on PIM-SM and they may coexist on a router. Whether PIM-SSM or PIM-SM is used is subject to the multicast address in a data or protocol packet. IANA assigns SSM an address segment (232.0.0.0 to 232.255.255.255). The multicast groups on this address segment will not join an RPT but is processed by SSM. In PIM-SSM, Hello packets are also transmitted periodically between routers for neighbor discovery and DR election.

Usually IGMPv3 is deployed on the host to establish and maintain multicast group memberships. Compared with IGMPv2, IGMPv3 is designed with the source-based filtering function. This function allows a host to receive only the data from a specific group and even from a specific source in this group. Based on a received IS_IN packet of IGMPv3, the SSM-enabled router learns that a host on the network connected with the interface receiving the IS_IN packet wants to receive (S,G) packets. This router unicasts a PIM (S,G) Join message to the next-hop router of the multicast source hop by hop and thereby an SPT can be established between the multicast source and the last-hop router. When the multicast source is sending multicast data, the data reaches the receiver along the SPT.

If a host supports only IGMPv1/IGMPv2, you can configure SSM mapping on the router connected with the host to convert the (*,G) Join messages of IGMPv1/IGMPv2 into (S,G) Join messages.

29.2 Configure PIM

29.2.1 PIM Configuration List

The operations listed in the table must be performed sequentially during PIM configuration. It is recommended that PIM-DM be enabled on all the interfaces of a non-border router running in PIM-DM domains. In contrast, PIM-SM does not need to be enabled on every interface.

Configuration Task	Description	Detailed Configuration
Basic PIM Configuration	Required	29.2.2
Advanced PIM Configuration	Required	29.2.3

29.2.2 Basic PIM Configuration

Operation	Command	Remarks
Enables PIM-DM on an interface.	ip pim dense-mode	
Disables PIM-DM on an interface.	undo ip pim dense-mode	
Enables PIM-SM on an interface.	ip pim sparse-mode	
Disables PIM-SM on an interface.	undo ip pim sparse-mode	

Note:

Enable a multicast protocol before PIM-SM on an interface.

29.2.3 Advanced PIM Configuration

Operation	Command	Remarks
-----------	---------	---------

Configures the transmission interval of Hello packets.	ip pim query-interval <i>seconds</i>	
Restores the default transmission interval.	undo ip pim query-interval	
Configures an interface as the border of a BSR.	ip pim bsr-border	
Deletes the BSR border configuration of an interface.	undo ip pim bsr-border	
Enters the PIM mode.	pim	
Quits the PIM mode.	quit	
Filters the received multicast packets based on the source.	source-policy <i>acl-number</i>	
Cancels source-based filtering.	undo source-policy	
Filters PIM neighbors.	ip pim neighbor-policy <i>acl-number</i>	
Cancels PIM neighbor filtering.	undo ip pim neighbor-policy	
Configures the maximum of PIM neighbors for an interface.	ip pim neighbor-limit <i>limit</i>	
Restores the default value.	undo ip pim neighbor-limit	
Configures a static RP.	static-rp <i>address</i>	
Deletes a static RP.	undo static-rp	
Configures a C-BSR.	bsr-candidate <i>interface-type</i>	

	<i>interface-number hash-mask-length priority</i>	
Deletes a C-BSR.	undo bsr-candidate	
Configures a C-RP.	rp-candidate <i>interface-type</i> <i>interface-number</i> group-list <i>acl-number</i> <i>priority</i>	
Deletes a C-RP.	rp-candidate <i>interface-type</i> <i>interface-number</i> group-list <i>acl-number</i>	
Configures a switching threshold.	spt-threshold { <i>immediately</i> <i>infinity</i> }	
Restores the default switching threshold.	undo spt-threshold	
Displays the information of PIM interfaces.	display ip pim interface [<i>vlan-interface</i> <i>vid</i>]	
Displays the information of PIM neighbors.	display ip pim neighbor	
Displays the multicast routing tables learned by PIM, including static and dynamic routing entries.	display ip mroute <i>group-address</i> [<i>static</i> <i>dynamic</i>]	
Displays dynamic and static RPs of PIM.	display ip pim rp-info <i>group-address</i>	
Displays the information of BSRs, including the elected BSR and local	display ip pim bs	

C-BSRs.		
Displays the range of SSM group addresses.	display ip pim ssm range	
Configures the range of an SSM multicast group.	ssm { default range acl }	
Deletes the configuration of the range of an SSM multicast group.	undo ssm { default range acl }	

Note: Be sure to enable PIM on an interface before Configure the PIM attributes of the interface. This point must be noted when you use the commands for Configure interface attributes and will not be given again.

Ensure that all the devices in the domain are configured with the same range of SSM multicast group addresses. Otherwise, multicast information cannot be transmitted using the SSM model.

If members of an SSM multicast group send Join messages over IGMPv1 or IGMPv2, (*,G) Join messages will not be triggered.

Chapter 30 SNTP

30.1 SNTP Overview

The Simple Network Time Protocol Version 4 (SNTPv4), which is a subset of the Network Time Protocol (NTP) used to synchronize computer clocks in the Internet. In common, there is at least one server in the network, it provides reference time for clients, finally, all clients in the network synchronized local clocks.

30.1.1 SNTP Operation Mechanism

SNTPv4 can be worked in four modes: unicast, multicast, broadcast and anycast. In unicast mode, client actively sends a request to server, and server sends reply packet to client according to the local time structure after receiving requirement.

In broadcast and multicast modes, server sends broadcast and multicast packets to client periodically, and client receives packet from server passively.

In anycast mode, client actively sends request to local broadcast or multicast address, and all servers in the network will reply to the client. Client will choose the server whose reply packet is first received to be the server, and drops packets from others. After choosing the server, working mode is the same as that of the unicast.

In all modes, after receiving the reply packet, client resolves this packet to obtain current

standard time, and calculates network transmit delay and local time complementary, and then adjusts current time according them.

30.2 Configure SNTP Client

30.2.1 SNTP Client Configuration List

Configuration Task	Description	Detailed Configuration
Enable SNTP client	Required	30.2.2
Modify SNTP client mode	Optional	30.2.3
Configure SNTP sever IP address	Optional	30.2.4
Modify broadcast transfer delay	Optional	30.2.5
Configure multicast TTL	Optional	30.2.6
Configure interval polling	Optional	30.2.7
Configure overtime retransmit	Optional	30.2.8
Configure valid sever list	Optional	30.2.9
Configure MD5 authentication	Optional	30.2.10
Display and maintain SNTP client	Optional	30.2.11

30.2.2 Enable SNTP Client

Operation	Command	Remarks
Enter global configuration mode	system-view	
Enable SNTP client	sntp client	

Disable SNTP client	undo sntp client	
---------------------	-------------------------	--

30.2.3 Modifying SNTP Client Operating Mode

Administrators can modify SNTP operating mode according to the network----- unicast, multicast, broadcast or anycast.

Operation	Command	Remarks
Enter globally configuration mode	system-view	
modifying SNTP client Operation mode	sntp client mode { broadcast unicast multicast anycast [key key] }	Broadcast modeby default

30.2.4 Configure SNTP Sever Address

SNTP client must configure appointed SNTP sever in the unicast way. You can also use below Commands to configure key when connecting to SNTP server by authentication.

Operation	Command	Remarks
Enter globally configuration mode	system-view	
configure SNTP sever address	sntp server IP [key key]	

30.2.5 Modifying Broadcast Transfer Delay

When SNTP client works in the broadcast or multicast way, it needs to use broadcast transfer delay. In the broadcast way, the local time of SNTP client equals the time receiving from sever adds transferring time. Administrators modify the transferring time according to the actual bandwidth in the network.

Operation	Command	Remarks
-----------	---------	---------

Enter globally configuration mode	system-view	
configure broadcast transfer delay	sntp client broadcastdelay <i>time</i>	3ms by default

30.2.6 Configure Multicast TTL

To restrict the pass range of multicast message, SNTP client needs configure the sending multicast TTL when working both in the any cast and in the request way of forwarding the multicast address.

Operation	Command	Remarks
Enter globally configuration	system-view	
Configure multicast TTL	sntp client multicast ttl <i>tll</i>	255 by default

30.2.7 Configure Interval Polling

Configure interval polling is necessary when SNTP client works in the uticast or any cast way. SNTP client adjusts the local system time by each interval polling requesting to sever.

Operation	Command	Remarks
Enter globally configuration mode	system-view	
Enter port configuration mode	interface ethernet <i>device/slot/port</i>	
Configure interval polling	sntp client poll-interval <i>time</i>	1000s by default

30.2.8 Configure Overtime Retransmist

This Command is effective in unicast and any cast operating mode. SNTP request packet is UDP packet, overtime retransmission system is adopted because the requirement packet cannot be guaranteed to send to the destination. Use above Commands to configure retransmit times

and the interval.

Operation	Command	Remarks
Enter globally configuration mode	system-view	
configure overtime retransmit	sntp client retransmit-interval <i>time</i>	5s by default,
configure overtime retransmit times	sntp client retransmit <i>times</i>	By default 0, means do not retransmit

30.2.9 Configure Valid Servers

In broadcast and multicast mode, SNTP client receives protocol packets from all servers without distinction. When there is malice attacking server (it will not provide correct time), local time cannot be the standard time. To solve this problem, a series of valid servers can be listed to filtrate source address of the packet.

Operation	Command	Remarks
Enter globally configuration mode	system-view	
configure valid servers	sntp client valid-server <i>IP mask</i>	

30.2.10 Configure MD5 Authentication

To enhance the safety, MD5 authentication can be setup between SNTP sever and SNTP client which only receives the authenticated message. MD5 authentication configures as below:

Operation	Command	Remarks
Enter globally configuration mode	system-view	
Startup MD5 authentication	sntp client authenticate	

Configure authentication keys	sntp client authentication-key <i>key-number</i> md5 <i>value</i>	
-------------------------------	--	--

30.2.11 Display and Maintain SNTP Client

After finishing above configuration, you can use below Commands to display SNTP client configuration.

Operation	Command	Remarks
Display and maintain SNTP client	display sntp client	

Chapter 31 802.1X

31.1 802.1X Overview

IEEE 802.1X is the accessing management protocol standard based on interface accessing control passed in June, 2001. Traditional LAN does not provide accessing authentication. Users access the devices and resources in LAN when connecting to the LAN, which is a security hidden trouble. For application of motion office and CPN, device provider hopes to control and configure user's connecting. There is also the need for accounting.

IEEE 802.1X is a network accessing control technology based on interface which is the accessing devices authentication and control by physical accessing level of LAN devices. Physical accessing level here means the interface of LAN GPON devices. When getting authentication, GPON is the in-between (agency) of client and authentication server. It obtains user's identity from client of accessing GPON and verifies the information through authentication server. If the authentication passes, this user is allowed to access LAN resources or it will be refused.

31.1.1 Architecture of 802.1X

802.1X operates in the typical client/server model and defines three entities: supplicant system, authenticator system, and authentication server system.

Supplicant system: A system at one end of the LAN segment, which is authenticated by the

authenticator system at the other end. A supplicant system is usually a user-end device and initiates 802.1x authentication through 802.1x client software supporting the EAP over LANs (EAPOL) protocol.

Authenticator system: A system at the other end of the LAN segment, which authenticates the connected supplicant system. An authenticator system is usually an 802.1x-enabled network device and provides ports (physical or logical) for supplicants to access the LAN.

Authentication server system: The system providing authentication, authorization, and accounting services for the authenticator system. The authentication server, usually a Remote Authentication Dial-in User Service (RADIUS) server, maintains user information like username, password, VLAN that the user belongs to, committed access rate (CAR) parameters, priority, and ACLs.

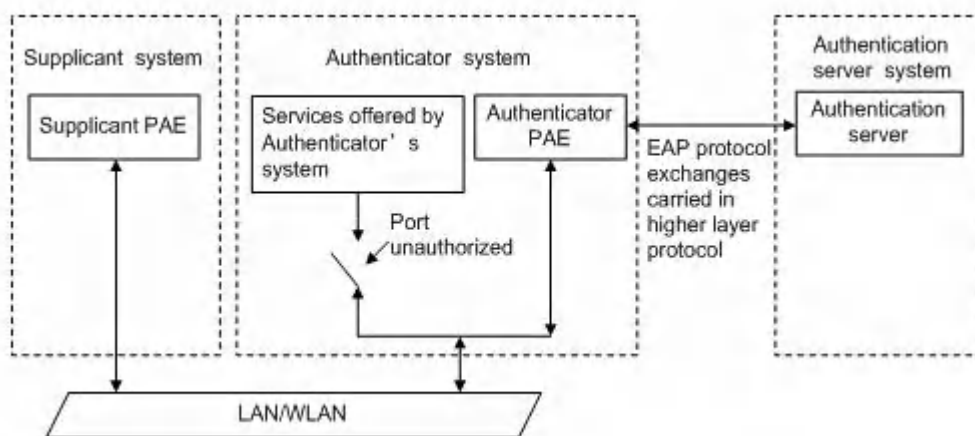

The above systems involve three basic concepts: PAE, controlled port, control direction.

1) PAE

Port access entity (PAE) refers to the entity that performs the 802.1x algorithm and protocol

operations.

The authenticator PAE uses the authentication server to authenticate a supplicant trying to access the LAN and controls the status of the controlled port according to the authentication result, putting the controlled port in the authorized or unauthorized state. In authorized state, the port allows user data to pass, enabling the supplicant(s) to access the network resources; while in unauthorized state, the port denies all data of the supplicant(s).

The supplicant PAE responds to the authentication request of the authenticator PAE and provides authentication information. The supplicant PAE can also send authentication requests and logoff requests to the authenticator.

2) Controlled port and uncontrolled port

An authenticator provides ports for supplicants to access the LAN. Each of the ports can be regarded as two logical ports: a controlled port and an uncontrolled port.

The uncontrolled port is always open in both the inbound and outbound directions to allow EAPOL protocol frames to pass, guaranteeing that the supplicant can always send and receive authentication frames.

The controlled port is open to allow normal traffic to pass only when it is in the authorized state.

The controlled port and uncontrolled port are two parts of the same port. Any frames arriving at the port are visible to both of them.

3) Control direction

In the unauthorized state, the controlled port can be set to deny traffic to and from the supplicant or just the traffic from the supplicant.

31.1.2 Rule of 802.1x

The 802.1x authentication system employs the Extensible Authentication Protocol (EAP) to exchange authentication information between the supplicant PAE, authenticator PAE, and authentication server.

At present, the EAP relay mode supports four authentication methods: EAP-MD5, EAP-TLS (Transport Layer Security), EAP-TTLS (Tunneled Transport Layer Security), and PEAP (Protected Extensible Authentication Protocol).

- 1) When a user launches the 802.1x client software and enters the registered username and password, the 802.1x client software generates an EAPOL-Start frame and sends it to the authenticator to initiate an authentication process.
- 2) Upon receiving the EAPOL-Start frame, the authenticator responds with an EAP-Request/Identity packet for the username of the supplicant.
- 3) When the supplicant receives the EAP-Request/Identity packet, it encapsulates the username in an EAP-Response/Identity packet and sends the packet to the authenticator.
- 4) Upon receiving the EAP-Response/Identity packet, the authenticator relays the packet in a RADIUS Access-Request packet to the authentication server.
- 5) When receiving the RADIUS Access-Request packet, the RADIUS server compares the identify information against its user information table to obtain the corresponding password information. Then, it encrypts the password information using a randomly generated challenge, and sends the challenge information through a RADIUS Access-Challenge packet to the authenticator.
- 6) After receiving the RADIUS Access-Challenge packet, the authenticator relays the contained EAP-Request/MD5 Challenge packet to the supplicant.

- 7) When receiving the EAP-Request/MD5 Challenge packet, the supplicant uses the offered challenge to encrypt the password part (this process is not reversible), creates an EAP-Response/MD5 Challenge packet, and then sends the packet to the authenticator.
- 8) After receiving the EAP-Response/MD5 Challenge packet, the authenticator relays the packet in a RADIUS Access-Request packet to the authentication server.
- 9) When receiving the RADIUS Access-Request packet, the RADIUS server compares the password information encapsulated in the packet with that generated by itself. If the two are identical, the authentication server considers the user valid and sends to the authenticator a RADIUS Access-Accept packet.
- 10) Upon receiving the RADIUS Access-Accept packet, the authenticator opens the port to grant the access request of the supplicant. After the supplicant gets online, the authenticator periodically sends handshake requests to the supplicant to check whether the supplicant is still online. By default, if two consecutive handshake attempts end up with failure, the authenticator concludes that the supplicant has gone offline and performs the necessary operations, guaranteeing that the authenticator always knows when a supplicant goes offline.
- 11) The supplicant can also send an EAPOL-Logoff frame to the authenticator to go offline unsolicitedly. In this case, the authenticator changes the status of the port from authorized to unauthorized and sends an EAP-Failure frame to the supplicant.

31.2 Configure AAA

Finish necessary configuration of domain and RDIUS project of 802.1X authentication.

31.2.1 Configure RADIUS Server

RADIUS server saves valid user's identity. When authentication, system transfers user's identity to RADIUS server and transfer the validation to user. User accessing to system can access LAN resources after authentication of RADIUS server.

Operation	Command	Remarks
Enter global configuration mode	system-view	
Enter AAA mode	aaa	
Enter RADIUS configuration	radius host <i>radius-name</i>	
Configure primary auth RADIUS	primary-auth-ip <i>ip-address port</i>	
Configure primary acct RADIUS	primary-acct-ip <i>ip-address port</i>	
Configure second auth RADIUS	second-auth-ip <i>ip-address port</i>	
Configure second acct RADIUS	second-acct-ip <i>ip-address port</i>	
Configure key string of RADIUS	auth-secret-key <i>keystring</i>	
Configure key string of RADIUS	acct -secret-key <i>keystring</i>	
Configure NAS-RADIUS address	nas-ipaddress <i>ip-address</i>	
Setup the username format	username-format { <i>with-domain</i> <i>without-domain</i> }	
Configure accounting	realtime-account	
Configure the times of accounting	realtime-account interval <i>account-times</i>	

31.2.2 Configure Local User

Client need configure local user name and password.

Operation	Command	Remarks
Enter global configuration mode	system-view	
Enter AAA mode	aaa	
Configure local user	local-user username <i>name</i> password <i>pwd</i> [vlan <i>vlan-id</i>]	

31.2.3 Configure Domain

Client need provide username and password when authentication. Username contains user's ISP information, domain and ISP corresponded. The main information of domain is the RADIUS server authentication and accounting the user should be.

Operation	Command	Remarks
Enter global configuration mode	system-view	
Enter AAA mode	aaa	
Configure default Domain	default domain-name { disable enable }	
setup Domain	domain <i>domain-name</i>	
Configure default Domain scheme	scheme { local radius [local] }	
choice RADIUS name	radius host binding <i>radius-name</i>	
configure access limit users	access-limit { enable <i>number</i> disable }	
active the state	state { active block }	

31.2.4 Configure RADIUS Features

Configure RADIUS some compatible or special features as below:

Operation	Command	Remarks
-----------	---------	---------

Enter global configuration mode	system-view	
Enter AAA mode	aaa	
Enable user re-authentication, when it executives	accounting-on { enable account-num disable }	
H3C Cams compatible under this feature can uprate-value / dnrate-value to configure the upstream bandwidth / downstream bandwidth of the Vendor Specific attribute name of the attribute number.	h3c-cams { enable disable }	
Accounting function	radius accounting	
Accounting packets without response need cut off users	radius server-disconnect drop 1x	
Enable port priority	radius 8021p enable	This feature is turned on, if the user authentication passes, it will be modified by the user where the priority of the port.
Enable port PVID	radius vlan enable	This feature is turned on, if the user authentication

		passes , it will be modified by the user where port PVID is
Enable limit port of MAC address numbers	radius mac-address-number enable	This feature is turned on, if the user authentication passes, the user will modify the port about the limiting number of MAC address learning.
Enable limit port bandwidth	radius bandwidth-limit enable	By default unit is kbps, can be modified through radius config-attribute access-bandwidth unit.

31.3 Configure 802.1X

31.3.1 Configure EAP

The 802.1X authentication can be initiated by either a supplicant or the authenticator system. A supplicant can initiate authentication by launching the 802.1x client software to send an EAPOL-Start frame to the authenticator system, while an authenticator system can initiate authentication by unsolicitedly sending an EAP-Request/Identity packet to an unauthenticated

supplicant.

Operation	Command	Remarks
Enter global configuration mode	system-view	
set the protocol type between system and RADIUS	dot1x { eap-finish eap-transfer }	

31.3.2 Enable 802.1x

802.1x provides a user identity authentication scheme. However, 802.1x cannot implement the authentication scheme solely by itself. RADIUS or local authentication must be configured to work with 802.1x

Enabling 802.1S authentication, users connected to the system can access to LAN per passing the authentication.

Operation	Command	Remarks
Enter global configuration mode	system-view	
Enable 802.1x	dot1x method { macbased portbased }	

31.3.3 Configure 802.1x Parameters for a Port

The 802.1x proxy detection function depends on the online user handshake function. Be sure to enable handshake before enabling proxy detection and to disable proxy detection before disabling handshake.

Operation	Command	Remarks
Enter global configuration mode	system-view	
Configure 802.1x parameters for a	dot1x port-control { auto forceauthorized }	

port	forceunauthorized } [interface ethernet <i>interface-list</i>]	
------	---	--

31.3.4 Configure Re-Authentication

In EAP-FINISH way, the port supports re-authentication. After the user is authenticated, the port can be configured to immediately re-certification, or periodic re-certification.

Operation	Command	Remarks
Enter global configuration mode	system-view	
Immediately re-certification	dot1x re-authenticate [interface ethernet <i>interface-list</i>]	
Periodic re-authentication enabled on a port	dot1x re-authentication [interface ethernet <i>interface-list</i>]	
Periodic re-authentication time configuration port	dot1x timeout re-authperiod <i>time</i> [interface ethernet <i>interface-list</i>]	

31.3.5 Configure Watch Feature

Opening function, the port without the user's circumstances, will watch regularly sends a 1x packet, triggering the following 802.1x user authentication.

Operation	Command	Remarks
Enter global configuration mode	system-view	
Open the watch function	dot1x daemon [interface ethernet <i>interface-list</i>]	
Configuration time between sending	dot1x daemontime [interface ethernet	

packets Watch	<i>interface-list</i>]	
---------------	-------------------------	--

31.3.6 Configure User Features

The operations mainly conclude of the number of users for port configuration, user and delete users, and heartbeat detection operations.

Operation	Command	Remarks
Enter global configuration mode	system-view	
Configuration allows the maximum number of users through the authentication	dot1x max-user <i>user-num</i> [interface ethernet <i>interface-list</i>]	
Deletes the specified users online	dot1x user cut { username <i>name</i> mac-address <i>mac-address</i> }	
Open heartbeat detection	dot1x detect [interface ethernet <i>interface-list</i>]	
Heartbeat detection time configuration	dot1x detect interval <i>time</i>	

Chapter 32 LLDP

32.1 LLDP Overview

LLDP (Link Layer Discovery Protocol), a L2 protocol, defined by IEEE802.1AB-2005 standard has nothing to do with the manufacturer. It announces its information to other neighbor devices in the network, receives the neighbor's information and saves to standard MIB of LLDP for users to check the downlink devices and connected ports for easy network maintenance and management. Network administrator can know L2 connections by accessing.

32.1.1 LLDP Fundamentals

LLDP devices announce their own information through multicast address 01-80-c2-00-00-0e. LLDP devices will send 2 LLDP notice and the sending interval is set by hello-time. After receiving neighbor's advertisement, LLDP device will read the advertisement content and save in LLDP neighbor table. LLDP neighbor table can be aged with TTL value being aging time. If neighbor's LLDP advertisement cannot be received within aging time, the neighbor entry will be removed.

32.1.2 LLDP Timer

Hello-time: The time interval for sending LLDP packet.

Hold-time: LLDP aging time granularity for neighbor entry.

TTL: TTL equals to hello-time ties hold-time which means aging time of neighbor entry.

32.2 Configure LLDP

32.2.1 LLDP Configuration List

Configuration Task	Description	Detailed Configuration
Enable LLDP	Required	32.2.2
Configure LLDP Hello-time	Optional	32.2.3
Configure LLDP Hold-time	Optional	32.2.4
Configure LLDP packet sending & receiving mode	Optional	32.2.5
Configure LLDP managementaddress	Optional	32.2.6
LLDP display and debugging	Optional	32.2.7

32.2.2 Enable LLDP

Only after enabling global LLDP, all related configurations can be effective. Global and port LLDP can be configured and saved no matter the LLDP is enabled. When global LLDP is enabled, the configuration is effective.

Operation	Command	Remarks
Enter global configuration mode	system-view	
Enable LLDP	lldp	
Disable LLDP	undo lldp	Disabled by default
Enter port configuration mode	interface ethernet <i>interface-num</i>	
Disable interface LLDP	undo lldp	Enabled by default

32.2.3 ConfigureLLDP Hello-Time

By default, LLDP Hello-time is 30S.

Operation	Command	Remarks
Enter global configuration mode	system-view	-
Configure LLDP Hello-time	lldp hello-time <i>time</i>	hello-time: <5-32768>(seconds)
Configure default LLDP Hello-time	undo lldp hello-time	

32.2.4 Configure LLDP Hold-Time

By default, LLDP Hold-time is 4S.

Operation	Command	Remarks
Enter global configuration mode	system-view	
Configure LLDP Hello-time	lldp hold-time <i>time</i>	hold-time: <2-10>(seconds)
Configure default LLDP Hello-time	undo lldp hold-time	

32.2.5 Configure LLDP Packet Transferring and Receiving Mode on Port

There are three types of mode:

Rx: receiving only.

Tx: transferring only.

Rxtx: transferring and receiving.

By default, the mode for all ports is rxtx, that is, transferring and receiving all LLDP packets.

Operation	Command	Remarks
Enter global configuration mode	system-view	
Enter port configuration mode	interface ethernet <i>interface-num</i>	

Configure LLDP packet transferring and receiving mode on port	lldp { rx rxtx tx }	
---	--------------------------------	--

32.2.6 Configure LLDP Management Address

Management address is the IP address of the device. LLDP devices use the vlan-interface IP address to encapsulate the LLDP packet and send the packet to the neighbor.

Operation	Command	Remarks
Enter global configuration mode	system-view	
Enter port configuration mode	interface ethernet <i>interface-num</i>	
Configure management address	lldp management-address { vlan-interface supervlan-interface } <i>vlan-id</i>	
Delete management address	undo lldp management-address	

32.2.7 LLDP Display and Debugging

After the above configurations, you can execute the display commands in any configuration mode to display information, so as to verify your configurations.

Operation	Command	Remarks
Display LLDP status	display lldp [interface ethernet <i>interface-num</i>]	

Chapter 33 PPPoE Plus

33.1 PPPoE Plus Overview

The Point-to-Point Protocol over Ethernet (PPPoE) is a network protocol for encapsulating Point-to-Point Protocol (PPP) frames inside Ethernet frames. It is used mainly with DSL services where individual users connect to the DSL modem over Ethernet and in plain Metro Ethernet networks. It was developed by UUNET, Redback Networks and RouterWare and is available as an informational RFC 2516.

33.2 Configure PPPoE Plus

33.2.1 PPPoE Plus Configuration List

Configuration Task	Description	Detailed Configuration
Enable PPPoE Plus	Required	33.2.2
Configure Option Content	Optional	33.2.3
PPPoE Plus Monitor and Maintenance	Optional	33.2.4

33.2.2 Enable PPPoE Plus

PPPoE packet will be forwarded to trust port. Trust port should be configured after enable this function. Generally, PPPoE plus will add option content to PPPoE packet. If the received PPPoE packet has contained option content, the handling strategy will be defined.

Operation	Command	Remarks
Enter global configuration mode	system-view	
Enable PPPoE Plus	pppoeplus	
Disable PPPoE Plus	undo pppoeplus	
Enter interface configuration mode	interface ethernet <i>interface-num</i>	
Configure PPPoE trust port	pppoeplus trust	
Delete PPPoE trust port	undo pppoeplus trust	
Configure option strategy	pppoeplus strategy { drop keep replace transmit }	
Configure PPPoE drop PADO/PADI	pppoeplus drop { padi pado }	
Delete PPPoE drop PADO/PADI	undo pppoeplus drop { padi pado }	

33.2.3 ConfigureOption Content

The option content need to be added before PPPoE packet forwarding out, the contents of this option can be determined by a variety of ways. Option content can be specified in interface configuration mode. If the content is not specified, it will be constructed according to configured rules. If pppoe plus type is self-defined, the format should also be specified.

Operation	Command	Remarks
Enter global configuration mode	system-view	
Configure PPPoE Plus type	pppoeplus type { huawei standard self-defined { circuit-id { string vlan port switch-mac hostname client-mac } * remote-id { string switch-mac hostname client-mac } * }	
Configure default PPPoE Plus type	undo pppoeplus type	By default, type

		is standard
Configure format	pppoeplus format { binary ascii }	Optional
Configure default format	undo pppoeplus format	By default, it is binary
Configure delimiter	pppoeplus delimiter { colon dot slash space }	
Configure default delimiter	undo pppoeplus delimiter	By default, it is space
Enter interface configuration mode	interface ethernet <i>interface-num</i>	
Specify circuit ID	pppoeplus circuit-id <i>string</i>	
Delete PPPoE cid	undo pppoeplus circuit-id	

33.2.4 PPPoE Plus Monitor and Maintenance

After finishing above configuration, user can check the configurations by command below.

Operation	Command	Remarks
Display PPPoE Plus configuration	display pppoeplus interface [ethernet <i>interface-list</i>]	

Chapter 34 CFM

34.1 CFM Overview

CFM (Connectivity Fault Management, the connectivity fault management protocol), defined by the IEEE 802.1ag standard is a Layer 2 link on the VLAN-based end to end OAM mechanism used to Carrier Ethernet fault management.

34.1.1 CFM Concepts

Concept	Remark
MD	<p>Maintenancefieldindicates that even the fault detectionis covered through a network of its boundary is configured onaportrangedefined by the MEPs. Maintenance ofthe domain of "Maintain the domain name"to identify, according to network planning can be divided into eight levels.</p> <p>Between different domains can bemaintained adjacent toor nested, but can't cross,and the nesteddomain can only bemaintainedby the high-level domain to the lowlevel maintenancenested, that is, low-levelmaintenance ofthe domain mustbeincluded in the domainof high-level maintenance department.</p>
Maintenance set	<p>Within the maintenancedomain can be configured as neededto maintain multiple sets, eachset ismaintained withinsomemaintenance to maintainthe set point.</p> <p>Maintenanceset to "maintainthedomain name +maintenanceset name"to identify.</p>

	<p>Maintain set service on a VLAN, to maintain focus on the maintenance point of sending packets of the band and the VLAN tag, at the same time Maintain focus on the maintenance point can receive by Maintain focus on its maintenance points sent the message.</p>
Maintenance point	<p>Maintenance points configured on a port, part of a maintenance set, can be divided into MEPs and MIPs two.</p> <p>(1) MEP ID in order to maintain endpoint identity, which defines the scope and maintenance of the domain boundary. MEP has a directional, sub-UP MEP and DOWN MEP for the two. MEP direction that the maintenance of domain relative to the location of the port. DOWN MEP is the port where to send its message, UP MEP port where it is not sent to the message, but it is the port to the device send its message.</p> <p>(2) Maintenance in the maintenance of the domain between points within the department, not the main action issued CFM protocol packets, but can handle and respond to CFM protocol packets.</p>

34.1.2 CFM Main Function

Connectivity fault detection based on a reasonable and effective application deployment and configuration over the network, its function is maintained in the configuration between points, as long as the following functions:

Function	Remark
Continuity detection	It is a proactive OAM functionality is used to detect the state to maintain connectivity between endpoints. Connectivity failure may be caused by equipment failure or

	configuration error.
Loopback	It is a kind of on-demand OAM functions for the local device and remote authentication between end devices connected state.
Link tracking	It is a kind of on-demand OAM functions for the local device to determine the path between the remote devices, in order to achieve the positioning of link failure.

34.2 Configure CFM

CFM function in the configuration before the network should carry the following plan:

- For the maintenance of the entire network to carry out sub-domain level, determine the level of maintenance of the domain boundary.
- Determine the maintenance of the domain name, the same domain on a different device to maintain the same name.
- Required monitoring of VLAN, determine the set of maintenance within the maintenance domain.
- Determine the maintenance set name, the same maintenance domain within the same set on different devices to maintain the same name.
- That the same maintenance domain within the same set of maintenance to maintain a list of endpoints in the different devices should remain the same.
- In the maintenance field and set the boundaries of the maintenance port on the endpoint should be planned maintenance, non-border or port equipment maintenance can be planned on a mid-point.
- After the completion of network planning, come line the following configuration.

34.2.1 CFM Configuration List

Configuration Task	Description	Detailed Configuration
Maintain Field Configuration	Required	34.2.2
Configuration and maintenance level domain name	Required	34.2.3
Configure to maintain set	Required	34.2.4
Configure name and the associated VLAN to maintain set	Required	34.2.5
Configure MEPs	Required	34.2.6
Configure Remote Maintenance endpoint	Required	34.2.7
Configure MIPs	Optional	34.2.8
Configure continuity detection	Required	34.2.9
Configure loopback	Optional	34.2.10
Configure link tracking	Optional	34.2.11
Display and maintenance of the CFM	Optional	34.2.12

34.2.2 Maintain Field Configuration

Operation	Command	Remarks
Enter global configuration mode	system-view	
Create a maintenance domain, and domain configuration into maintenance mode	cfm md md-index	

34.2.3 Configuration and Maintenance Level Domain Name

In order to distinguish between the various maintenance domain, you can specify a different domain for each maintenance of domain names, the name by the name of the format and content of two parts, the whole network a unique domain name is best; to display nested relationship between the maintenance domain, must also designated to maintain the domain level, only the level of maintenance of large domain nested level can only be a small maintenance domain.

Operation	Command	Remarks
Enter global configuration mode	system-view	
Domain configuration into maintenance mode	cfm md <i>md-index</i>	
Configuration without the maintenance of domain names, only the specified field level maintenance	cfm md format none level <i>md-level</i>	
Equipped with the maintenance of the domain name, and specify the domain name and level of maintenance	cfm md format { dns-name mac-uint string } name <i>md-name level md-level</i>	

34.2.4 Configure Maintain Set

Operation	Command	Remarks
Enter global configuration mode	system-view	
To maintain the domain configuration	cfm md <i>md-index</i>	

mode to enter		
Created to maintain set, and enter the configuration mode set to maintain	cfm ma ma-index	

34.2.5 Configure Name and Associated VLAN to Maintain Set

In order to maintain the distinction between the various domains to maintain set, you can specify a different set for each to maintain the instance name, instance name, the name by the name of the format and content of two parts, the maintenance of set where the maintenance of the domain name plus the instance name must ensure that all network only.

Operation	Command	Remarks
Enter global configuration mode	system-view	
To maintain the domain configuration mode to enter	cfm md md-index	
Enter the configuration mode set to maintain	cfm ma ma-index	
The name of the configuration set and maintain the VLAN associated with the main	cfm ma format { primary-vid string uint16 vpn-id } name ma-name primary-vlan vlan-id	

34.2.6 Configure MEPs

CFM is mainly reflected in the maintenance of a variety of endpoints operating on, the user can program the network port on the network configuration to maintain the boundary endpoints.

Operation	Command	Remarks
Enter global configuration mode	system-view	
To maintain the domain configuration mode to enter	cfm md <i>md-index</i>	
Enter the configuration mode set to maintain	cfm ma <i>ma-index</i>	
Create a maintenance endpoint, and specify its associated port	cfm mep <i>mep-id</i> direction { up down } [primary-vlan <i>vlan-id</i>] interface ethernet <i>port-id</i>	
Enable the state to maintain endpoint management	cfm mep <i>mep-id</i> state { enable disable }	Required Default is off
CCM and configure the endpoint to send maintenance to use the priority LTM	cfm mep <i>mep-id</i> priority <i>priority-id</i>	Optional Default priority is 0

34.2.7 Configure Remote Maintenance Endpoint

Remote maintenance end point is equivalent to the local maintenance of the end points, and in the maintenance of concentration, in addition to the maintenance of the local endpoint, all other maintenance endpoints should be configured in the local endpoint for the remote maintenance.

Operation	Command	Remarks
Enter global configuration mode	system-view	

To maintain the domain configuration mode to enter	cfm md <i>md-index</i>	
Enter the configuration mode set to maintain	cfm ma <i>ma-index</i>	
Creating remote maintenance end point, and specify the end of its peer MEPs	cfm rmep <i>rmep-id mep mep-id</i>	

34.2.8 Configure MIPs

MIPs used to test the response of CFM message, the user can program the network device or in non-border ports configured to maintain the mid-point.

Operation	Command	Remarks
Enter global configuration mode	system-view	
To maintain the domain configuration mode to enter	cfm md <i>md-index</i>	
Enter the configuration mode set to maintain	cfm ma <i>ma-index</i>	
Create a maintenance intermediate point, and specify its associated port	cfm mip <i>mip-id interface ethernet port-id</i>	

34.2.9 Configure Continuity Detection

Continuity detection through configuration, can be made to maintain interoperability between endpoint CCM packets to check the connectivity between these endpoints maintain

state in order to achieve the link connectivity management.

Operation	Command	Remarks
Enter global configuration mode	system-view	
To maintain the domain configuration mode to enter	cfm md <i>md-index</i>	
Enter the configuration mode set to maintain	cfm ma <i>ma-index</i>	
Configuration maintenance interval endpoint to send the CCM	cfm cc interval { 1 10 60 600 }	1s by default
Enable sending MEP ccm	cfm mep <i>mep-id</i> cc { enable disable }	Default is off

Caution:

Different devices at the same maintenance domain and maintain a centralized maintenance endpoint, the sending time interval of CCM must be the same.

34.2.10 Configure Loopback

By Configure the loopback function, you can check the source to the target MEPs MEPs or MIPs link between the situations in order to achieve the link connectivity verification.

Operation	Command	Remarks
Enter global configuration mode	system-view	
To maintain the domain configuration mode to enter	cfm md <i>md-index</i>	
Enter the configuration mode set to	cfm ma <i>ma-index</i>	

maintain		
Start loopback	cfm loopback mep <i>mep-id</i> { dst-mac <i>mac-address</i> dst-mep <i>rmep-id</i> } [priority <i>pri-id</i> count <i>pkt-num</i> length <i>data-len</i> <i>datapkt-data</i>]	

34.2.11 ConfigureLink Tracking

By Configure the link tracking, you can find the source to the target MEPs MEPs or maintenance intermediate point between the path in order to achieve the positioning of link failure.

Operation	Command	Remarks
Enter global configuration mode	system-view	
To maintain the domain configuration mode to enter	cfm md <i>md-index</i>	
Enter the configuration mode set to maintain	cfm ma <i>ma-index</i>	
Start Tracking link	cfm linktrace mep <i>mep-id</i> { dst-mac <i>mac-address</i> dst-mep <i>rmep-id</i> } [timeout <i>pkt-time</i> tll <i>pkt-ttl</i> flag { <i>use-mpdb</i> <i>unuse-mpdb</i> }]	

34.2.12 Display and Maintenance of CFM

After completing the above configuration, you can use the following command to display the

CFM configuration.

Operation	Command	Remarks
The Maintenance domain information	display cfm md [<i>md-index</i>]	
The Maintenance Set Information	display cfm ma	
Display the end point of maintenance information	display cfm mp local	
Remote maintenance point information display	display cfm mp remote	
Display CCM statistics	display cfm cc	
Clear CCM statistics	clear cfm cc	
CCM database information display	display cfm cc database	
Clear CCM database information	clear cfm cc database	
CFM alarm information display	display cfm errors	

Chapter 35 EFM

35.1 EFM Overview

EFM (Ethernet of First Mile) as the first mile Ethernet, defined by the IEEE 802.3ah standard, used for the two devices point to point Ethernet link between the management and maintenance.

35.1.1 EFM Main Function

EFM Ethernet can effectively improve the management and maintenance capabilities to ensure the stable operation of the network, its main features include:

Function	Remarks
EFM auto-discovery	EFM functionality built on the basis of connections, EFM connection establishment process is achieved by the auto-discovery of EFM. EFM work in two modes: active mode and passive mode, EFM connected only by the active mode of EFM entity initiated the passive mode EFM physical entity can only wait for the end of the connection requests are in a passive mode of the two an EFM can't be established between the entities connected.
Remote failure indication	When the device detects a link event of an emergency, the fault will end EFM entity's Flag by Information OAMPDU fault information field (the type of emergency event link) EFM notification to the peer entity. In this way, administrators can log information by observing the dynamic understanding of the link state, the

	<p>corresponding error in a timely manner for processing.</p> <p>Event types, including emergency Link Fault, Dying Gasp and Critical Event of three.</p>
Link monitoring capabilities	<p>Link monitoring function is used in a variety of environments and found that the link layer fault detection, EFM through interactive Event Notification OAMPDU to monitor the link: When the end of the EFM to detect the general physical link event, the Event Notification sent to its peer OAMPDU for notification, the administrator can log information by observing the network to dynamically control the situation.</p> <p>Event types include general link-errored-symbol-period, errored-frame, errored-frame-period, errored-frame-seconds four.</p>
Remote loopback	<p>Remote loopback is active mode EFM entity sends to the remote except OAMPDU than all other messages, the remote receives the packet forwarding address is not its purpose, but the road back to its original The end.</p> <p>Remote loopback is controlled by remote Loopback Control OAMPDU remote loopback or remote loopback operation to cancel the function can be used to detect the link quality and positioning of link failure.</p>
Remote access to MIB variable function	<p>EFM entities can interact with Variable Request / Response OAMPDU far end of the entity to obtain the MIB variable value.Include Ethernet MIB variable chain on the road all the performance parameters and error statistics. It provides a local EFM physical entity on the far side of the general performance and error detection mechanisms.</p>

Description:

We said so to the EFM port functions as "EFM Entities".

35.1.2 EFM Protocol Packets

EFM working in the data link layer, the protocol packet is called OAMPDU (OAM Protocol Data Units, OAM protocol data unit). EFM is through regular interaction between the device OAMPDU to report link status, enabling network administrators to effectively manage the network.

Message type	Effect
Information OAMPDU	EFM entity status for the information (including local information, the remote information and custom information) sent to the remote entity EFM, EFM connections to maintain.
Event Notification OAMPDU	Generally used for link monitoring on local and remote connected EFM physical link failures in the warning.
Loopback Control OAMPDU	Mainly use for remote loopback control in order to control the EFM loopback state of remote device. The packet has the information of enabling or disabling loopback .Enabling or disabling remote loopback based on this information.
Variable Request / Response OAMPDU	Mainly used for remoteMIBvariable values, in order to achieve the end of the remote state prosecution.

35.2 Configure EFM

35.2.1 EFM Configuration List

Configuration Task	Description	Detailed Configuration
EFM Basic Configuration	Required	35.2.2
Configure EFM Timer Parameter	Optional	35.2.3
Configure Remote Failure Indication	Optional	35.2.4
Configure Link Monitoring Capabilities	Optional	35.2.5
Enabling Remote Loopback	Optional	35.2.6
Rejecting Remote Loopback Requests Initiated by Remote	Optional	35.2.7
Initiating a Remote Loopback Request	Optional	35.2.8
Starting Remote Access Function MIB Variable	Optional	35.2.9
MIB Variable Access Requests Initiated by Remote	Optional	35.2.10
Display and Maintenance of EFM	Optional	35.2.11

35.2.2 EFM Basic Configuration

EFM mode of operation is divided into proactive mode and passive mode, when the EFM function enabled, the Ethernet port started to use the default mode of operation and the establishment of its peer port connected EFM.

Operation	Command	Remarks
Enter global configuration mode	system-view	
Enter port configuration mode.	interface ethernet <i>interface-num</i>	-
StartEFM	efm	By default, EFM is off

EFMmode configuration	efm mode { passive active }	By default, EFM mode to active mode
-----------------------	--------------------------------------	-------------------------------------

35.2.3 Configure EFM Timer Parameter

EFM connection is established, both ends of the EFM entity will be a certain time interval to send Information OAMPDU cycle to detect whether the connection is normal, the interval is called the interval to send handshake packets. If one end of the connection timeout EFM entity within an entity does not receive remote EFM sent Information OAMPDU, EFM is considered disconnected.

EFM handshake by adjusting packet transmission interval and the connection timeout, the connection can change the EFM detection accuracy. With Configure OAMPDU remote request message to the response timeout, then discard the message which receiving the later response message to the OAMPDU if the time is out.

Operation	Command	Remarks
Enter global configuration mode	system-view	
Enter port configuration mode.	interface ethernet <i>interface-num</i>	
Configure the interval to send handshake packets EFM	efm pdu-timeout <i>time</i>	1s by default
Configure the connection timeout EFM	efm link-timeout <i>time</i>	5s by default

Response timeout configuration	efm remote-response-timeout <i>time</i>	2s by default
--------------------------------	--	---------------

Caution:

Because EFM connection times out, the local entity will EFM EFM aging and physical connection to the end of the relationship, the EFM connection is broken, so the connection must be greater than the timeout interval to send handshake packets (Recommended for 3 times or more) , otherwise it will lead to EFM connection instability.

35.2.4 Configure Remote Failure Indication

Operation	Command	Remarks
Enter global configuration mode	system-view	
Enter port configuration mode.	interface ethernet <i>interface-num</i>	
Startremote failure indication	efm remote-failure { link-fault dying-gasp critical-event }	By default,remote failure indication is enabled

Description:

Remote failure indication function device supports a single-pass function required to detect the local emergency link to the remote event notification, in the single-pass functions are not supported on the device, the local emergency is detected only in the event link end of reporting alarms and can't notify the remote.

35.2.5 Configure Link Monitoring Capabilities

Operation	Command	Remarks
Enter global configuration mode	system-view	
Enter port configuration mode.	interface ethernet <i>interface-num</i>	
Start link monitoring capabilities	efm link-monitor { errored-symbol-period errored-frame errored-frame-period errored-frame-seconds }	By default, the link monitoring is enabled
Configure errored-symbol-period event detection cycle	efm link-monitor errored-symbol-period window high <i>win-value1</i> low <i>win-value2</i>	
Configure errored-symbol-period event detection threshold	efm link-monitor errored-symbol-period threshold high <i>th-value1</i> low <i>th-value2</i>	
Configure errored-frame event detection cycle	efm link-monitor errored-frame window <i>win-value</i>	
Configure errored-frame event detection threshold	efm link-monitor errored-frame threshold <i>th-value</i>	
Configure errored-frame-period event detection cycle	efm link-monitor errored-frame-period window <i>win-value</i>	
Configure errored-frame-period event detection threshold	efm link-monitor errored-frame-period threshold <i>th-value</i>	
Configure errored-frame-second event detection cycle	efm link-monitor errored-frame-seconds window <i>win-value</i>	
Configure errored-frame-second event detection threshold	efm link-monitor errored-frame-seconds threshold <i>th-value</i>	

Description:

- errored-symbol-period threshold event detection cycle and a 64-bit integer value, **high** and **low** parameter values, respectively, after the value of the high and low 32-bit, that is, the integer value = **(high * (2 ^ 32)) + low**.

35.2.6 Enabling Remote Loopback

By default, loopback at the far end is in the off state. It can only support the far end loopback device starts far end loopback.

Operation	Command	Remarks
Enter global configuration mode	system-view	
Enter port configuration mode.	interface ethernet <i>interface-num</i>	
Start remote loopback	efm remote-loopback	

35.2.7 Rejecting Remote Loopback Requests Initiated by Remote

As the remote loopback function will be affected normal business in order to avoid this situation, users can configure the local port of the peer sent from the Loopback Control OAMPDU control, which refused to end the remote initiated EFM loopback request.

Operation	Command	Remarks
Enter global configuration mode	system-view	
Enter port configuration mode.	interface ethernet <i>interface-num</i>	
Reject remote loopback requests initiated by remote	efm remote-loopback { ignore process }	By default, the remote refused

		to initiate a remote loopback request
--	--	---------------------------------------

35.2.8 Initiating a Remote Loopback Request

Operation	Command	Remarks
Enter global configuration mode	system-view	
Enter port configuration mode.	interface ethernet <i>interface-num</i>	
Initiate a remote loopback request	efm remote-loopback { start stop }	

Description:

- Only when the port EFM connection has been created, and the mode of EFM proactive mode, in order to launch on the far side of the port loopback request.
- Only the port side and far side far side loopback support feature, and in full-duplex chain on the road to achieve the far end loopback.
- In the open far end loopback, it will cause all data traffic in off; when the exit far end loopback, the local and remote port will be back to normal. Lead to far-side exit port loopback reasons: use undo EFM command to close the EFM function, use the EFM remote-loopback stop command or exit the far end loopback connected EFM over time and so on.

35.2.9 Starting Remote Access Function MIB Variable

Operation	Command	Remarks
-----------	---------	---------

Enter global configuration mode	system-view	
Enter port configuration mode.	interface ethernet <i>interface-num</i>	
Start the remote access function MIB variable	efm variable-retrieval	By default, remote access to MIB variable is enabled

35.2.10 MIB Variable Access Requests Initiated by Remote

Operation	Command	Remarks
Enter global configuration mode	system-view	
Enter port configuration mode.	interface ethernet <i>interface-num</i>	
Port for the remote device MIB variable value	display efm port <i>port-id-list</i> remote-mib { phyadminstate autonegadminstate }	
Access to remote devices global MIB variable values	display efm remote-mib { fecability fecmode }	

Description:

- Only when the port EFM connection has been created, EFM working model is for the proactive mode, the far side far side port supports MIB variable access function to the port on the far end of the MIB variable for initiating the request.
- Currently only supports remote query capability of FEC, FEC mode, port status and port to enable auto-negotiation enabled, the other MIB variables can later be added on demand to achieve.

35.2.11 Display and Maintenance of EFM

After completing the above configuration, you can use the following command to display the EFM configuration.

Operation	Command	Remarks
Display EFM protocol running	display efm status interface [ethernet interface-num]	
Display summary information EFM	display efm summary	
Display EFM find information	display efm discovery interface [ethernet interface-num]	
Display EFM protocol packet statistics	display efm statistics interface [ethernet interface-num]	
Clear EFM protocol packet statistics	clear efm statistics interface [ethernet interface-num]	

Chapter 36 ERRP

36.1 ERRP Overview

Ethernet Redundant Ring Protocol is a link layer protocol specifically designed for Ethernet ring. It prevents broadcast storms caused by data loops when the Ethernet ring is complete; when a link on the Ethernet ring is disconnected, the communication path between the nodes on the ring network can be quickly restored. Compared with STP, ERRP has the characteristics of fast topological convergence speed and convergence time independent of the number of nodes on the ring network.

In order to avoid conflict between ERRP and STP in calculating port congestion / release status, ERRP and STP are mutually exclusive on the enabled port. That is, the STP protocol cannot be enabled by the two ports connected to the ERRP ring, and STP can be enabled by the other ports.

36.1.1 Concept Introduction

ERRP region

The ERRP region is identified by an integer ID. A set of GPON groups configured with the same domain ID, control VLAN and connected to each other form an ERRP domain. An ERRP domain has the following constituent elements:

- ERRP loop
- VLAN controlled by ERRP
- Master node
- Transport node
- Edge node and assistant edge node

ERRP loop

The ERRP ring is also identified by an integer ID, and an ERRP ring physically corresponds to a ring-connected Ethernet topology. An ERRP domain consists of an ERRP ring or multiple ERRP rings that are connected to each other. One of them is the master ring and the other ring is a sub-ring. The master ring and the sub-ring are distinguished by the specified level at the time of configuration. The level of the primary ring is 0 and the level of the sub-ring is 1.

The ERRP ring has two states:

Health state: All links of the ring are normal and the physical link of the ring is connected.

Fault state: The link on the ERRP ring is faulty. One or many physical links of the ring network are down.

Node role

The node on the ERRP ring is divided into the master node and the transit node. The node role is specified by the user. The master node is the decision-making and control node for ring

protection. Each ERRP ring must specify only one master node. All nodes except the master node are called transit nodes.

If more than one ERRP ring intersects, one of the intersecting nodes is designated as an edge node and the other intersecting node is designated as an assistant edge node. The role of the two nodes on the master ring is the transit node. The two nodes role of the sub-ring is the edge node and the assistant edge node. The specific role of the sub-ring can be specified by the user. There is no special requirement, mainly to distinguish the two nodes.

Port role

Each node of an ERRP ring has two ports connected to a ring. User can specify one of the ports as the primary port and the other port as the secondary port. The master port of the master node is used to send health detection message (hello message), received from the secondary port of the main node. The master port and secondary port of the transit node are functionally indistinguishable. To prevent the loop from causing broadcast storms, if the ERRP ring is normal, the secondary port of the master node is blocked and all the other ports are in the forwarding state.

If multiple ERRP rings intersect, the ports in the intersecting nodes that access both the primary ring and the sub-ring (that is, the port of the primary ring and the sub-ring common link) are called common ports at the same time. Only the ports that access the sub-rings are called edge ports. Conceptually, a public port is not considered to be a port of a sub-ring, it is regarded as part of the main ring, that is, the public link is the link of the primary ring, not the

link of the sub-ring. The state change of the public link is only reported to the master node of the primary ring. The master node of the sub-ring does not need to know.

Control VLAN

Control VLAN is relative to the data VLAN, the data VLAN is used to transmit data messages, control VLAN is used to transmit ERRP protocol messages.

Each ERRP region has two control VLANs, called the primary control VLAN and the sub-control VLAN. The protocol message of the primary ring is propagated in the master control VLAN, and the protocol message of the sub-ring is propagated in the sub-control VLAN. User need to specify the primary control VLAN. The VLAN that is one greater than the master control VLAN ID, is used as the sub-control VLAN.

Only port (ERRP port) connecting the Ethernet of each GPON belongs to the control VLAN, and the other ports cannot join the control VLAN. The ERRP port of the primary ring belongs to both the primary control VLAN and the sub-control VLAN. The ERRP port of the sub-ring belongs to the sub-control VLAN. The data VLAN can contain ERRP ports or non-ERRP ports. The primary ring is regarded as a logical node of the sub-ring. The protocol messages of the sub-ring are transmitted through the primary ring and processed in the primary ring as data messages. The protocol messages of the primary ring are transmitted only within the primary ring. Don't enter sub-rings.

Query Solicit function

ERRP is used in conjunction with IGMP Snooping, if the topology of the ERRP changes, the forwarding state of the port will be changed. If the multicast state is not updated through the IGMP Snooping module after the port state changes, the multicast forwarding may become abnormal. To introduce the query solicit function. When a topology change occurs in the ERRP, the device sends a query solicit message or a general IGMP query message to all the ports so that the member port re-initiates an IGMP report to update the multicast entry.

36.1.2 Protocol Message

HELLO message

The hello message is initiated by the master node, and detects loop integrity of the network. The master node periodically sends HELLO message from its primary port, and the transit node forwards the message to the next node, which is then received by the secondary port of the master node. Periodically send, and the sending period is Hello timer.

LINK_UP message

The LINK_UP message is initiated by the transit node, edge node, or assistant edge node that recovers the link. It informs the master node that there is link recovery on the loop. Trigger to send.

LINK_DOWN message

The LINK_DOWN message is initiated by the transit node, edge node, or assistant edge node that fails the link. It informs the master node that there is link failure on the loop, and the physical loop disappears. Trigger to send.

COMMON_FLUSH_FDB message

It is initiated by the master node, and informs the transit node, the edge node and the assistant edge node to update their respective MAC address forwarding tables. Trigger on link failure or link recovery.

COMPLETE_FLUSH_FDB message

It is initiated by the master node, and informs the transit node, the edge node and the assistant edge node to update their respective MAC address forwarding tables, and informs the transit node to release the blocked state of the port temporarily blocking the data VLAN. It is sent when the link recovery (That is, the secondary port of the master node receives Hello packets) is complete.

EDGE_HELLO message

The EDGE_HELLO message is initiated by the edge node of the sub-ring to check the loop integrity of the major ring in the domain.

Edge nodes send EDGE_HELLO messages periodically from the two ports connected to the primary ring. The nodes in the primary ring process the message as data message and receive

them from the assistant edge nodes on the same sub-ring. Periodically send, sending cycle is the Edge Hello timer.

MAJOR_FAULT message

The MAJOR_FAULT message is originated by the assistant edge node and reports to the edge node that the primary ring of the domain is faulty. When the assistant edge node of the sun-ring cannot receive the EDGE_HELLO message from the edge node in the specified time, the assistant edge node sends a MAJOR_FAULT message from its edge port. After the sub-ring node receives the message, it forwards the message directly to the next node, and finally the edge node of same sub-ring receives. Periodically send after triggering, the sending period is Edge Hello timer.

36.1.3 Operate Principle

Health status

The master node periodically sends the hello message from its primary port, which in turn travels through the transit nodes of the ring. If the secondary port of the master node receives a hello message before it times out, it considers that the ERRP ring is health status. The status of the master node reflects the health of the ring. When the ring network is in a healthy state, the master node blocks its secondary port in order to prevent the data message from forming a broadcast loop.

Link failure

Two mechanisms are provided for detecting link failures:

(1) LINK_DOWN escalation and processing:

When an ERRP port of the transit node detects a port Link Down, the node sends a LINK_DOWN message to the master node from the ERRP PORT in the up state that is paired with the faulty port.

After the master node receives the LINK_DOWN message, the node state is immediately changed for failed state. Disable the blocking state of the secondary port. The FDB table is refreshed and a COMMON_FLUSH_FDB message is sent from the primary and secondary ports to notify all transit nodes to refresh their respective FDB tables.

After receiving the COMMON_FLUSH_FDB message, the transit node immediately refreshes the FDB table and starts learning the new topology.

(2) Polling mechanism:

The fault reporting mechanism is initiated by the transit node. In order to prevent the LINK_DOWN message from losing during transmission, the master node implements the Polling mechanism. The Polling mechanism is the mechanism that the master node of the ERRP ring actively detects the health status of the ring network. The master node periodically sends HELLO message from its master port, and then transmits it through the transmission nodes.

If the master node can receive the HELLO message from the secondary port in time, it indicates that the ring network is complete and the master node will keep the secondary port blocked. If the secondary port of the master node cannot receive HELLO message in the specified time, it is considered that a link fault has occurred on the ring network. The fault handling process is the same as the LINK_DOWN process mechanism.

Link recovery

There are two situations to deal with:

(1) LINK_UP escalation and processing

After the ports of the transit node that belong to the ERRP region are re-up, the master node may find loop recovery after a certain period of time. In the time, the network may form a temporary loop, which makes data VLAN produce a broadcast storm.

In order to prevent the generation of the temporary loop, the transit node moves to the Preforwarding state and immediately blocks the port that has just been recovered, after it finds the port accessing the ring network re-up. At the same time, the transmitting node that has recovered the link sends a LINK_UP message to the master node from ERRP port that is paired with the recovery port in the UP state. After receiving the LINK_UP message from the transmitting node, the master node sends a COMMON_FLUSH_FDB message from the primary port and the secondary port to notify all transit nodes to refresh the FDB table. The

port recovered by the transit node only releases the blocked state after receiving the COMPLETE_FLUSH_FDB packet sent by the master node or the Preforward timer expires.

The response of the master node to the LINK_UP message does not represent the response processing to the ring network recovery. If multiple links on the ring network fail and then one of the links is restored, the LINK_UP reporting mechanism and the response mechanism of the master node are introduced to quickly refresh the FDB tables of the nodes on the ring.

(2) Ring network recovery processing:

Ring network recovery processing is initiated by the main node. The master node sends the Hello messages periodically from the master port. After the faulty link on the ring network is restored, the master node will receive its own test messages from the secondary port. After receiving the HELLO message from the host, the master node first moves the state back to the complete state, blocks the secondary port, and then sends the COMPLETE_FLUSH_FDB message from the primary port. After receiving the COMPLETE_FLUSH_FDB message, the transit node moves back to the Link_Up state, releases the temporarily blocked port, and refreshes the FDB table.

If the COMPLETE_FLUSH_FDB message is lost during transmission, a backup mechanism is adopted to recover the temporarily blocked port of the transit node. The transmission node is in the Pre-forwarding state, if the COMPLETE_FLUSH_FDB message from the master node is not received in the specified time, Self-release temporary blocking port, restore data

communication.

36.1.4 Multi-loop Intersection Processing

Multi-ring and single-ring is almost the same, The difference between a multi-ring and a single ring is that multiple rings are introduced the sub-ring protocol message channel state detection mechanism in the main ring, after the channel is interrupted, the edge port of the edge node is blocked before the secondary port of the master node of the sub-ring is released to prevent the data loop from forming between the sub-ring. For details, see Sub-channel Protocol Channel Status Check Mechanism on the Main Ring.

In addition, when a node on the master ring receives a COMMON-FLUSH-FDB or COMPLETE-FLUSH-FDB message from the sub-ring, it will refresh the FDB table. The COMPLETE-FLUSH-FDB of the sub-ring does not cause the sub ring transit node to release the temporarily blocked port. The COMPLETE-FLUSH-FDB message of the primary ring does not do so.

36.2 Configure ERRP

36.2.1 ERRP Configuration List

Configuration Task	Description	Detailed Configuration
ERRP Configuration List	Required	36.2.2

Configure Time Parameter	Optional	36.2.3
Configure Domain	Required	36.2.4
Configure Work Mode	Optional	36.2.5
Configure Control VLAN	Required	36.2.6
Configure the Ring	Required	36.2.7
Enable/Disable ERRP Ring	Required	36.2.8
Configure the Query Solicit Function	Optional	36.2.9
Configure the Topology Discovery Function	Optional	36.2.10
Display and Maintenance of ERRP	Optional	36.2.11

36.2.2 Enable/Disable ERRP

Operation	Command	Remarks
Enter the global configuration mode	system-view	
Enable ERRP	errp	
Disable ERRP	undo errp	

36.2.3 Configure Time Parameter

User can modify the ERRP timer parameters as requirement, but make sure that the timer parameters are the same on all nodes. Ensure that the value of the Failed timer is not less than 3 times the Hello timer value.

Operation	Command	Remarks
-----------	---------	---------

Enter the global configuration mode	system-view	
Enter the global configuration mode	errp hello-timer <i>value</i>	
Configure the health message timer	errp fail-timer <i>value</i>	
Configure the information timeout timer	errp preup-timer <i>value</i>	
Configure the recovery delay timer	errp hello-timer <i>value</i>	

36.2.4 Configure Domain

Operation	Command	Remarks
Enter the global configuration mode	system-view	
Create and enter the domain configuration mode	errp domain <i>domain-id</i>	
Delete domain	undo errp domain [<i>domain-id</i>]	

36.2.5 Configure Work Mode

In order to connect with other vendors device, user can modify the work mode in the ERRP domain, and configure multiple ERRP domains on the same device. Each domain can be configured with different work modes. All the nodes in the same ERRP domain must work in the same mode.

By default, it works in standard mode. Support compatible with EIPS and RRPP.

Operation	Command	Remarks
Enter the global configuration mode	system-view	

Create and enter the domain configuration mode	errp domain <i>domain-id</i>	
Configure work mode	workmode { standard huawei eips-subring }	

36.2.6 Configure Control VLAN

Control VLAN is relative to the data VLAN, the data VLAN is used to transmit data message, control VLAN is used to transmit ERRP protocol message.

Each ERRP domain has two control VLANs, called the primary control VLAN and the sub-control VLAN. The protocol messages of the primary ring are propagated in the master control VLAN, and the protocol messages of the sub-ring are propagated in the sub-control VLANs. User needs to specify only the primary control VLAN and a VLAN with the maximum control VLAN ID of 1 as the sub-control VLAN.

When an ERRP port sends protocol messages, it always takes control VLAN tags, regardless of whether the ERRP port is in trunk mode.

Operation	Command	Remarks
Enter the global configuration mode	system-view	
Create and enter the domain configuration mode	errp domain <i>domain-id</i>	
Configure control VLAN	control-vlan <i>vlan-id</i>	
Delete control VLAN	undo control-vlan	

36.2.7 Configure the Ring

To avoid conflict between ERRP and STP in calculating port blocking / releasing status, ERRP and STP are mutually exclusive on the port. Before specifying an ERRP port, user must disable STP on the port.

If a device is on multiple ERRP rings of the same ERRP domain, only one master ring can exist. The node role of the device on other sub-rings can be only the edge node or assistant edge node.

The ERRP field takes effect only when both the ERRP protocol and the ERRP ring enable. To enable the ring, user must first configure the control VLAN.

ERRP ring is divided into the main ring and sub-ring. Respectively use 0,1.

Operation	Command	Remarks
Enter the global configuration mode	system-view	
Create and enter the domain configuration mode	errp domain <i>domain-id</i>	
Configure ring and ring levels	ring <i>ring-id</i> role master primary-port <i>pri-port secondary-port sec-port level level</i>	
Configure transit node	ring <i>ring-id</i> roletransit primary-port <i>pri-port</i> secondary-port <i>sec-port level level</i>	
Configure edge node	ring <i>ring-id</i> roleedge common-port <i>common-port edge-port edge-port</i>	

Configure assistant-edgenode	ring <i>ring-id</i> role assistant-edge common-port <i>common-port</i> edge-port <i>edge-port</i>	
Delete ring	undo ring [<i>ring-id</i>]	

36.2.8 Enable/Disable ERRP Ring

Operation	Command	Remarks
Enter the global configuration mode	system-view	
Create and enter the domain configuration mode	errp domain <i>domain-id</i>	
Enable/Disable ERRP Ring	ring <i>ring-id</i> { enable disable }	

36.2.9 Configure the Query Solicit Function

This function is used to cooperate with IGMP SNOOPING. When the topology of the ERRP ring network changes, it immediately notifies the IGMP querier to resend the IGMP general query to update the IGMP SNOOPING multicast database in time. Currently, there is not related standard. The query solicit message is private and the IGMP type is 0xff.

Specific implementation is as follows:

1. The default Query solicitation function is enabled on the master node, the transit node closes Query solicitation function.
2. The master node topology change is determined by: The master node status is from Health

to Fault or from Fault to Health.

3. Other nodes topology changes are determined by: The primary and secondary port status is from forwarding to non-forwarding (block/disable) or from non-forwarding to forwarding (block/disable).

4. When the node detects a topology change: If the node itself is the IGMP querier, it immediately sends a General Query message to all the ports. Otherwise, immediately send a Query Solicit message to all ports;

5. After the IGMP querier receives the Query Solicit message: Respond immediately to the receiving port a General Query message.

Operation	Command	Remarks
Enter the global configuration mode	system-view	
Create and enter the domain configuration mode	errp domain <i>domain-id</i>	
Enable query-solicit	ring <i>ring-id</i> query-solicit	
Disable query-solicit	undo ring <i>ring-id</i> query-solicit	

36.2.10 Configure the Topology Discovery Function

Operation	Command	Remarks
Enter the global configuration mode	system-view	
Create and enter the domain configuration mode	errp domain <i>domain-id</i>	

Enable topo-collect	topo-collect	
Disable topo-collect	undo topo-collect	

36.2.11 Display and Maintenance of ERRP

Operation	Command	Remarks
Display ERRP Domain	display errp [domain <i>domain-id</i> [ring <i>ring-id</i>]]	
Display ERRP control-vlan	display errp control-vlan [<i>vlan-id</i>]	
Display ERRP topology discovery	display errp topology [domain <i>domain-id</i> [ring <i>ring-id</i>] summary [domain <i>domain-id</i> [ring <i>ring-id</i>]]	

Chapter 37 ERPS

37.1 ERPS Overview

ERPS (Ethernet Ring Protection Switching) is released by ITU-T with the convergence rate of telecommunication level. If all devices inside the ring support this agreement, it can achieve intercommunication.

37.1.1 ERPS Basic Conception

ERPS mainly includes ERPS ring, node, port role and port status.

1. ERPS Example

ERPS instance is formed by the same instance ID, control VLAN and interconnected GPON.

2. Control VLAN

Control VLAN is the transmission VLAN of ERPS protocol, and the protocol packet will carry corresponding VLAN tag.

3. RPL

RPL (Ring Protection Link), Link designated by mechanism that is blocked during Idle state to

prevent loop on Bridged ring

4. ERPS ring

ERPS ring is EPRS basic unit. It composed by a set of the same control VLAN and the interlinked L2 GPON equipment.

5. Node

The L2 equipment added in ERPS ring are called nodes. Each node cannot be added to more than two ports in the same ERPS ring. The nodes are divided into RPL Owner, Neighbor, Next Neighbor, and Common.

6. Port Role

In ERPS, port roles include: RPL Owner, Neighbor, Next Neighbor, and Common:

RPL Owner: An ERPS ring has only one RPL Owner port configured by the user and it prevents loops in the ERPS ring via blocking the RPL Owner port. The node that owns the RPL Owner port becomes the RPL Owner node.

RPL Neighbour: An ERPS ring has only one RPL Neighbor port configured by the user and it must be a port connected to the RPL Owner port. If the network is normal, it will block together with the RPL Owner port to prevent loops in the ERPS ring. The node with the RPL Neighbor port becomes the RPL Neighbor node.

RPL Next Neighbour: An ERPS ring can have up to two RPL Next Neighbor ports configured by the user. It must be the port connecting the RPL Owner node or the RPL Neighbor node. To become the RPL Next Neighbor node, the RPL Next Neighbor port should own the node of RPL Next Neighbor port.

Note:RPL Next Neighbour nodes are not much different from ordinary nodes. They can be replaced by Common nodes.

Common: The common port. The ports except RPL owner, Neighbor and Neighbor port are common ports. If the node has only the Common port, this node will become the Common node.

7. Port Status

In the ERPS ring, the port status of the ERPS protocol is divided into three types.

Forwarding: In Forwarding status, the port forwards user traffic and receives / forwards R-APS packets. Moreover, it forwards R-APS packets from other nodes.

Discarding: In the Discarding status, the port can only receive / forward R-APS packets and cannot forward R-APS packets from other nodes.

Disable: port in Linkdown status.

8. Wrok Mode: ERPS operating mode

Work mode includes: revertive and non-revertive.

Revertive: When the link fails, the RPL link is in the release protection state and the RPL link is re-protected after the faulty link is restored to prevent loops.

Non-revertive: After the fault is rectified, the faulty node remains faulty (without entering Forwarding) and the RPL link remains in the release protection state.

37.1.2 ERPS Ring Protection Mechanism

ERPS uses ETH CFM for link monitoring. When the network is normal, a blocking link is set on the ring network to prevent the ring network from ringing. If a fault occurs in the network, a blocked backup link is opened to ensure uninterrupted link between each node. The general process is as follows:

As shown , when six devices are connected in a ring and the link is in the IDLE state, the loop is removed via setting the RPL link and locking the port (RPL Owner port).

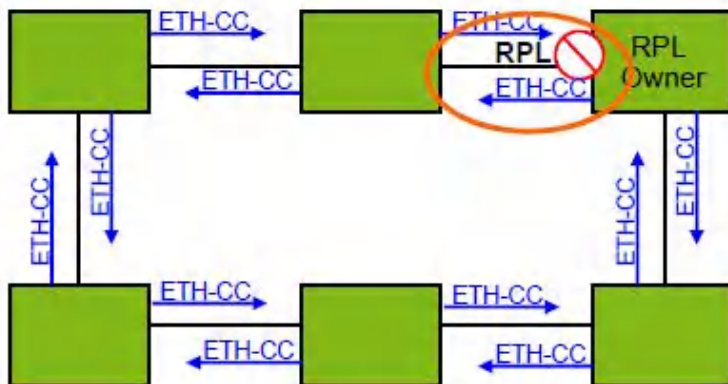

When a node on the link detects a fault, it immediately blocks the faulty node and reports the fault message (R-APS (SF)) to all the other devices in the ring. After receiving the message, all other nodes refresh the FDB. The RPL owner port receives the fault message, and the recovery port is in the forwarding state. The ERPS ring enters the protection state. As shown in the Figure:

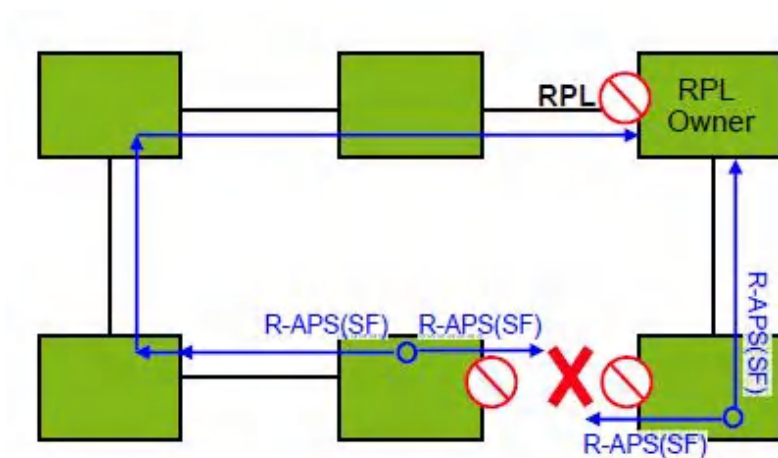

when the link of the faulty device recovers, it sends RAPS (NR) packets to other devices in the ring to inform them that there is no local request. When the RPL owner receives the packet, it will block the port and send the R-APS (NR, RB) message again after some time. After receiving the packet, the other nodes will refresh the FDB entry. Later, the port of the faulty node will be restored to the forwarding state, and the ring will revert to the IDLE state.

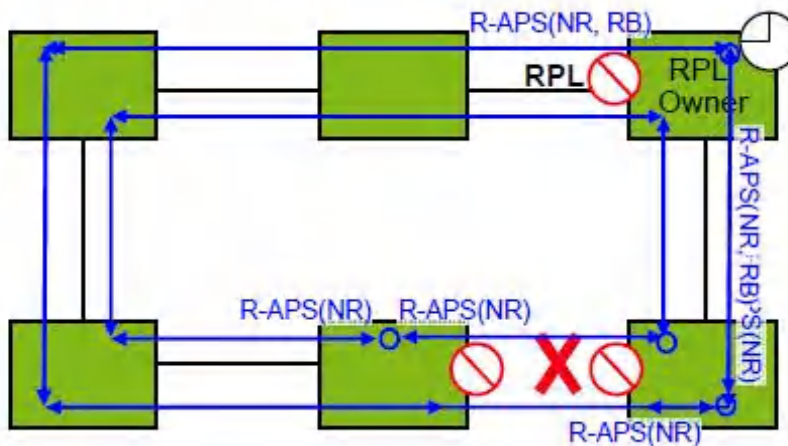

37.2 Configure ERPS

37.2.1 ERPS Configuration List

Configuration Task	Description	Detailed Configuration
Enable/Disable ERPS	Required	37.2.2
Configure ERPS Instance	Required	37.2.3
Configure Connectivity Detection of ERRP Link	Optional	37.2.4
Configure ERPS Related Timers	Optional	37.2.5
ERPS Display and Maintenance	Optional	37.2.6

37.2.2 Enable/Disable ERPS

Operation	Command	Remarks
Enter the global configuration mode	system-view	

Enable ERPS	erps	
Disable ERPS	undo erps	

37.2.3 Configure ERPS Instance

Operation	Command	Remarks
Enter the global configuration mode	system-view	
Configure erps instance	erps instance <i>instance-id</i>	
Configure control-vlan	control-vlan <i>vlan id</i>	
Configure work-mode	work-mode { revertive non-revertive }	
Configure ring id	ring <i>ring id</i>	
Configure ring level	ring <i>level</i>	
Configure ring port role	{ port0 port1 } ethernet <i>interface-num</i> [neighbor next-neighbour owner]	
Configure protected-instance	protected-instance <i>inst-list</i>	
Enable/Disable ring	ring [enable disable]	

Note:

About Ring ID: ERPS ring ID, the last byte of the DMAC in the R-APS message is Ring Id.

From G.8032 can be learned that the ERPS ring ID can be the same, and the control VLAN needs to be different. The reverse is also true. The ring ID of each instance can be 1 to 239, and the control VLAN does not allow duplication.

To configure ERPS port, you must disable the spanning tree.

37.2.4 Configure Connectivity Detection of ERRP Link

In ERPS, there is no HELLO packet to monitor link connectivity in real time. Instead, it uses the CC function in ETH CFM to detect the link connectivity by sending ETH-CC messages between the two ports. Therefore, you need to configure the CFM CC for the ports in the ERPS. In the ERRP instance, you need to configure the MEL (MEG level, which must be consistent with the CFM configuration).

For more information about CFM, please refer to the CFM User Manual.

Operation	Command	Remarks
Enter the global configuration mode	system-view	
Configure erps instance	erps instance <i>instance-id</i>	
Configure MEL	mel <i>level</i>	

37.2.5 Configure ERPS Related Timers

ERPS has two timers: WTR timer and Guard timer.

WTR timer: When the RPL owner port is restored to the Forwarding state due to another device or link failure, if the fault is restored and some ports may not have been changed from the Down state to the Up state, it starts the WTR timer when the RPL owner port receives the fault-free RAPS packet from a port to prevent the shock of blocking point; If the fault is received before the timer expires, the WTR timer is disabled. If a faulty RAPS packet from another port is received before the timer times out, the WTR timer will be disabled. If the WTR timer does not receive any faulty RAPS packets from other ports, it will block the RPL Owner

port and send RPL blocking RAPS packets after timed out. After receiving the packet, the other ports set the forwarding state of its own port as Forwarding state.

Guard timer: After the failure recovery, the equipment involved in link failure or node failure will send R-APS packet to the other devices and it will start the Guard Timer at the same time. The device does not process RAPS packets until the timer times out with the purpose to prevent the receipt of outdated faulty R-APS packets. If the device receives the faulty RAPS packet from another port after the timer times out, the port forwarding state will turn to Forwarding.

Operation	Command	Remarks
Enter the global configuration mode	system-view	
Configure erps instance	erps instance <i>instance-id</i>	
Configure wtr-timer	wtr-timer <i>timer value</i>	
Configure guard-timer	guard-timer <i>timer value</i>	

37.2.6 ERPS Display and Maintenance

Operation	Command	Remarks
Display ERPS information	display erps [instance <i>instance id</i>]	
Display control-vlan	display erps control-vlan [<i>vid</i>]	
Display the sending and receiving packets	display erps [instance <i>instance id</i>] statistics	
Display the sending and receiving packets	clear erps [instance <i>instance id</i>] statistics	

Chapter 38 FlexLink

38.1 FlexLink Overview

Flex links is layer 2 links backup protocol which provides for STP option scheme. Choose Flex links to realize link backup when the STP is not wanted in customer network. If STP enables, flex links is disabled. Flex links consists of a pair of interfaces (can be ports or convergent interface). One interface is transmitting data, the other is standby. The backup interface starts transmitting data when there is default in master link. The failure interface will be standby when it turns well and it will be transmitting data in 60 seconds when preempt mechanism is set. Flex links interface should disable STP and Flex links interface can configure bandwidth and delay being preempt mechanism and the superior one will be the master interface. There must be trap alarm when master or backup link default.

Flex Link is dedicated to dual-uplink networks. It delivers the following benefits:

- Keeping one uplink connected and the other blocked when both uplinks in a dual uplink network are healthy, thus preventing broadcast storms caused by network loops.
- Switching the traffic to the backup link within a few sub-seconds when the primary link fails, thus ensuring the normal forwarding of traffic in the network.
- Easy to configure.

38.1.1 Basic Concept of Flex Links

1. Flex Links group

A Flex link group consists of only two member ports: the master and the slave. At a time, only one port is active for forwarding, and the other port is blocked, that is, in the standby state.

When link failure occurs on the active port due to port shutdown or presence of unidirectional link for example, the standby port becomes active to take over while the original active port transits to the blocked state.

2. Master port

The master port of a Flex link group is a port role specified using commands. It can be an Ethernet port (electrical or optical), or an aggregate interface.

3. Slave port

The slave port of a Flex link group is another port role specified using commands. It can be an Ethernet port (electrical or optical), or an aggregate interface. The link on which the slave port resides is called the backup link.

4. MMU (MAC address-table Move Update)message

When link switch over occurs in a Flex link group, the old forwarding entries are no longer useful for the new topology. Therefore, all devices in the network need to refresh their MAC address forwarding entries. Flex Link notifies devices to refresh their MAC address forwarding entries by sending MMU messages to them.

38.1.2 Operating Mechanism of Flex Link

This section uses the network shown in the below figure to describe the Flex link mechanism as the link status transiting from normal, to faulty, and then to recovery.

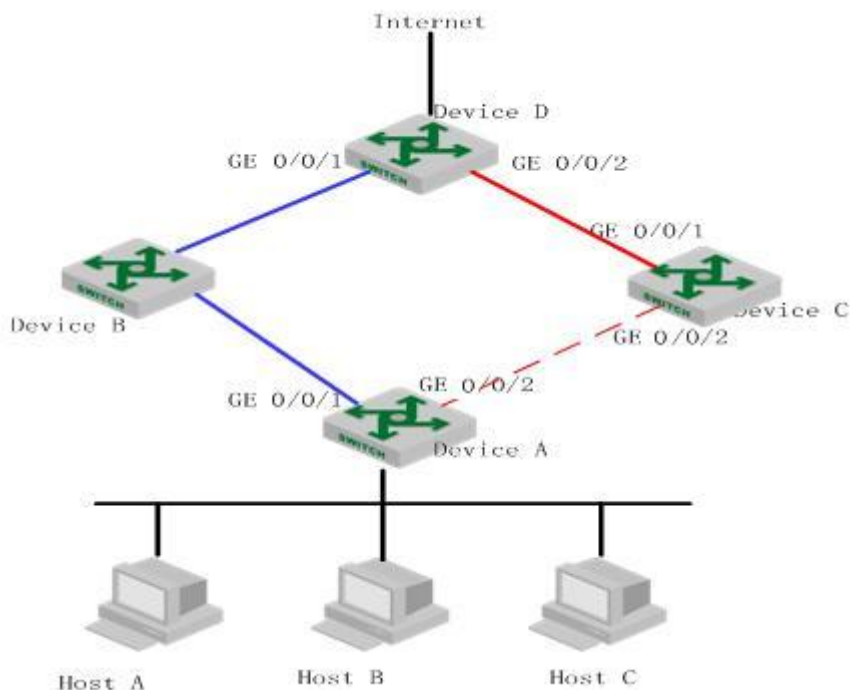

Link-Normal Operating

GigabitEthernet 0/0/1 and GigabitEthernet 0/0/2 of device A form a Flex link group, with the former as the master port and the latter as the slave port. When both uplinks are healthy, the master port is in the forwarding state, while the slave port is in the standby state, and the links on which the two ports are seated respectively are called the primary link and the backup link. In this case, data is transmitted along the link indicated by the blue line. There is no loop in the network, hence no broadcast storms either.

Link-Faulty Handling

When the primary link on device A fails, the master port GigabitEthernet 0/0/1 transits to the

standby state, while the slave port GigabitEthernet 0/0/2 transits to the forwarding state. A link switch over occurs. After the link switchover, the MAC address forwarding entries kept on the devices in the network may become incorrect, and need to be refreshed, so that traffic can be rapidly switched to another link, thus avoiding traffic loss. Currently, one mechanism is available for refreshing MAC address forwarding entries: MMU message-notified refreshing.

This mechanism is applicable when the upstream devices (such as device B, device C, and device D in the Figure) support Flex Link and are able to recognize MMU messages.

To enable rapid link switch over, you need to enable device A to send MMU messages, and all upstream devices' ports that are on the dual uplink network to receive and process MMU messages.

After link switchover occurs on device A, MMU messages are sent along the new primary link, that is, through GigabitEthernet 0/0/2. When an upstream device receives and handles a MMU message, transmit MAC address carried in the MMU message to the receiving port.

After that, when device D receives a data packet destined for Host A, Host B, Host C, device D will broadcasts the packet at Layer 2; device C will search MAC address table after receiving it, and forward it to device A from GE0/0/2; device A forward it to Host A, Host B, Host C. In this way, data traffic can be forwarded correctly.

This mechanism will update MAC address without waiting for entry aged. Generally, the whole link will be shifted in milliseconds without traffic lost.

Link-Recovery Working Modes

Flex Link supports three working modes: role preemption, non-role preemption and bandwidth

preemption. Under different modes, the port state changes are different:

- If role preemption is configured, when the primary link recovers, the master port enters the forwarding state and takes over the traffic, while the slave port enters the standby state. The slave port transits from standby to forwarding only when the primary link fails.
- If non-role preemption is configured, when the primary link recovers, the slave port remains in the forwarding state, while the master port remains in the standby state, so as to keep the traffic stable.
- If bandwidth preemption is configured, when the primary link recovers, the slave port remains in the forwarding state if it occupies more bandwidth, while the master port remains in the standby state; the slave port transits from forwarding to standby only when master port occupies more bandwidth.

As shown in the Figure, if role preemption is configured on the Flex link group on device A, when the link of GigabitEthernet 0/0/1 on device A recovers, GigabitEthernet 0/0/2 is immediately blocked and transits to the standby state, while GigabitEthernet 0/0/1 transits to the forwarding state. If non-role preemption is configured, when the link of GigabitEthernet 0/0/1 on device A recovers, GigabitEthernet 0/0/1 remains in the standby state, and no link switch over occurs, thus keeping the traffic stable.

38.2 Configure FlexLinks

38.2.1 FlexLinks Configuration List

Configuration Task	Description	Detailed Configuration
Configure Flex Links group	Required	38.2.2
Configure Flex Links preemption mode	Optional	38.2.3

Configure Flex links preemption delay	Optional	38.2.4
Configure Flex links MMU	Optional	38.2.5
Flex Links monitor and maintenance	Optional	38.2.6

38.2.2 Configure FlexLinks group

Configure Flex Links group needs specify master and slave port. If master port is Ethernet port, the configuration should be in interface configuration mode; if master port is channel-group port member, the configuration should be in global configuration mode.

Operation	Command	Remarks
Enter global configuration mode	system-view	
Configure Flex Links group	channel-group <i>channel-group-number_1</i> backup { interface <i>device/slot/port_2</i> channel-group <i>channel-group-number_2</i> }	<i>channel-group-number_1</i> is master port, <i>port_2/channel-group-number_2</i> is slave port
Delete Flex Links group	undo channel-group <i>channel-group-number_1</i> backup	
Enter interface configuration mode	interface ethernet <i>device/slot/port_1</i>	
Configure Flex Links group	port backup { interface <i>device/slot/port_2</i> channel-group <i>channel-group-number_2</i> }	<i>port_1</i> is master port, <i>port_2/channel-group-number_2</i> is slave port
Delete Flex Links group	undo port backup	

Note:

The STP of master port and slave port should be disabled, and cannot be ERRP port.

38.2.3 Configure FlexLinks Preemption Mode

At a time, only one port is active for forwarding, and the other port is blocked, that is, in the

standby state. When link failure occurs on the active port due to port shutdown or presence of unidirectional link for example, the standby port becomes active to take over while the original active port transits to the blocked state.

Operation	Command	Remarks
Enter global configuration mode	system-view	-
Configure Flex Links preemption mode	channel-group <i>channel-group-number_1</i> backup { interface <i>device/slot/port_2</i> channel-group <i>channel-group-number_2</i> } preemption mode { forced bandwidth off }	<i>channel-group-n</i> <i>umber_1</i> is master <i>port,port_2/chan</i> <i>nel-group-numbe</i> <i>r_2</i> is slave port
Enter interface configuration mode	interface ethernet <i>device/slot/port_1</i>	
Configure Flex Links preemption mode	port backup { interface <i>device/slot/port_2</i> channel-group <i>channel-group-number_2</i> } preemption mode { forced bandwidth off }	<i>port_1</i> is master port, <i>port_2/channel-g</i> <i>roup-number_2</i> is slave port

38.2.4 Configure FlexLinks Preemption Delay

After Configure Flex Links preemption mode, the port will not be active status immediately. There has to be a time delay. The default delay is 45s.

Operation	Command	Remarks
Enter global configuration mode	system-view	-
Configure Flex links preemption delay	channel-group <i>channel-group-number_1</i> backup { interface <i>device/slot/port_2</i> channel-group <i>channel-group-number_2</i> } preemption delay <1-60>	<i>channel-group-n</i> <i>umber_1</i> is master <i>port,port_2/chan</i> <i>nel-group-numbe</i> <i>r_2</i> is slave port
Enter interface configuration mode	interface ethernet <i>device/slot/port_1</i>	-
Configure Flex links preemption	port backup { interface <i>device/slot/port_2</i>	<i>port_1</i> is master

delay	channel-group <i>channel-group-number_2</i> } preemption mode <1-60>	port, <i>port_2/channel-g</i> <i>roup-number_2</i> is slave port
-------	---	---

38.2.5 Configure FlexLinks MMU

MMU messages are used by a Flex link group to notify other GPON to refresh their MAC address forwarding entries and ARP/ND entries when link switch over occurs in the Flex link group. MMU messages are common unicast data packets, and will be dropped by a blocked receiving port. This function is disabled by default.

Operation	Command	Remarks
Enter global configuration mode	system-view	-
Configure Flex links MMU	mac-address-table move update { transmit receive }	<i>port_1</i> is master port, <i>port_2/channel-g</i> <i>roup-number_2</i> is slave port

38.2.6 FLexLinks Monitor and Maintenance

After finishing above configuration, user can check the configurations by command below.

Operation	Command	Remarks
Display configured Flex Links group	display interface switch backup	
Display Flex Links MMU status	display mac-address-table move update	

Chapter 39 Monitorlink

39.1 Monitorlink Overview

Monitor Link is developed to complement the Flex Link feature. By monitoring the uplink, and synchronizing the downlink with the uplink, Monitor Link triggers the switch over between the primary and backup links in a Flex link group, thus perfecting the link redundancy mechanism of Flex Link.

39.1.1 Monitor Link Group

A monitor link group is a set of uplink and downlink ports. Downlink ports adapt to the state changes of uplink ports.

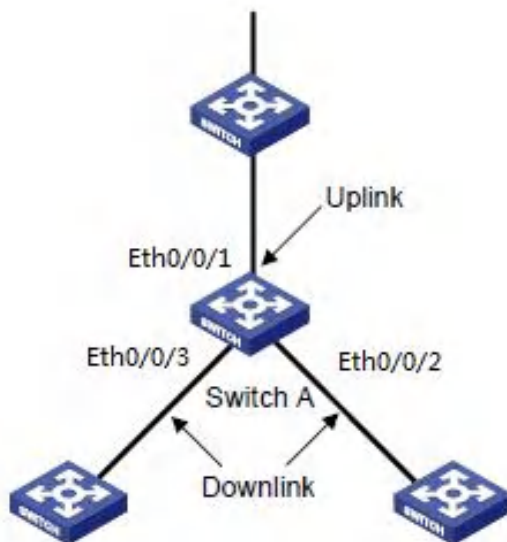

As shown in the figure, ports GigabitEthernet 0/0/1, GigabitEthernet 0/0/2, and GigabitEthernet 0/0/3 of GPON A form a monitor link group.

1. Uplink Port

An uplink port is a monitored port in a monitor link group. It is a port role specified using commands. It can be an Ethernet port (electrical or optical), or an aggregate interface.

As shown in the figure, GigabitEthernet 0/0/1 of GPON A is the only uplink port of the monitor link group configured on the device.

For a monitor link group that has multiple uplink ports, as long as at least one of its uplink ports is in the forwarding state, the monitor link group is up. However, when all uplink ports of the monitor link group fail, the monitor link group goes down, shutting down all the downlink ports.

If no uplink port is specified in a monitor link group, the system considers the monitor link group's uplink ports to be faulty, and thus shuts down all the downlink ports in the monitor link group.

2. Downlink Port

A downlink port is a monitoring port in a monitor link group. It is another port role specified using commands. It can be an Ethernet port (electrical or optical), or an aggregate interface.

As shown in the figure, GigabitEthernet 0/0/2 and GigabitEthernet 0/0/3 of device A are two downlink ports of the monitor link group configured on the device.

Note:

When a monitor link group's uplink ports recover, only downlink ports that were blocked due to uplink port failure will be brought up. Downlink ports manually shut down will not be brought up automatically. The failure of a downlink port does not affect the uplink ports or other downlink ports.

39.1.2 Monitor Link Mechanism

As shown in the below figure, to provide reliable access to the Internet for the hosts, a Flex link group is configured on device A. GigabitEthernet 0/0/1 is the master port of the Flex link group, and is in the forwarding state. GigabitEthernet 0/0/2 is the slave port.

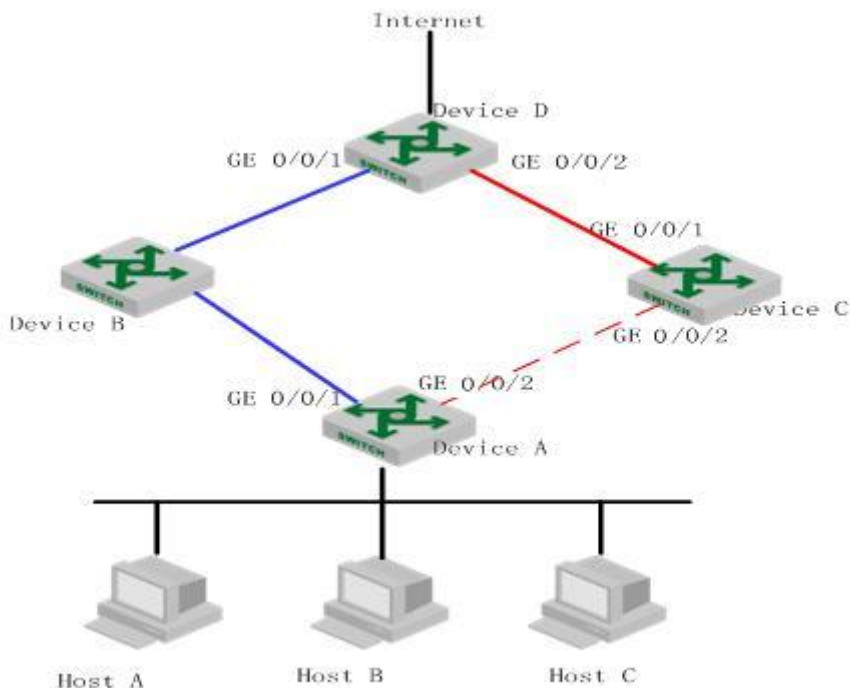

To avoid traffic interruption due to the failure of the link on which GigabitEthernet 0/0/1 of device B resides, configure a monitor link group on device B, and specify GigabitEthernet 0/0/1 as the uplink port, and GigabitEthernet 0/0/2 as the downlink port.

When the link on which GigabitEthernet 0/0/1 of device B resides fails, the monitor link group shuts down its downlink port GigabitEthernet 0/0/2, triggering a link switch over in the Flex link group configured on device A.

When the link on which GigabitEthernet 0/0/1 of device B resides recovers, the downlink port GigabitEthernet 0/0/2 is also brought up, triggering another link switch over in the Flex link group if role preemption is configured in the Flex link group on device A.

Collaboratively, Monitor Link and Flex Link deliver reliable link redundancy and fast convergence for dual-uplink networks.

39.2 Configure Monitor Link

39.2.1 MonitorLink Configuration List

Configuration Task	Description	Detailed Configuration
Configure MonitorLink Group	Required	39.2.2
Monitor Link monitor and maintenance	Optional	39.2.3

39.2.2 Configure MonitorLink Group

If the port is Ethernet port, configuration should be in interface configuration mode; if port is channel-group member, configuration should be in global configuration mode.

Operation	Command	Remarks
Enter global configuration mode	system-view	
Monitor Link for channel-group	channel-group <i>channel-group-number</i> monitor-link-group <i>group-ID</i> { uplink downlink }	
Delete channel-group from Monitor Link group	undo channel-group <i>channel-group-number</i> monitor-link-group <i>group-ID</i> { uplink downlink }	
Enter interface configuration mode	interface ethernet <i>device/slot/port</i>	
Monitor Link for port	port monitor-link-group <i>group-ID</i> { uplink downlink }	
Delete port from Monitor Link group	undo port monitor-link-group <i>group-ID</i> { uplink downlink }	

39.2.3 MonitorLink Monitor and Maintenance

After finishing above configuration, user can check the configurations by command below.

Operation	Command	Remarks
Display Monitor Link group	display monitor-link-group	

Chapter 40 L3 Base Function Configuration

40.1 L3 Base Function Overview

The L3 GPON is a 10-Gigabit intelligent routing GPON based on the application specific integrated circuit (ASIC) technology and supports layer 2 (L2) and layer 3 (L3) forwarding. It performs L2 forwarding when hosts in the same virtual local area network (VLAN) access each other and L3 forwarding when hosts in different VLANs access each other.

40.2 Configure L3 Base Function

40.2.1 L3 Base Function Configuration List

Configuration Task	Description	Detailed Configuration
Planning VLANs and creating L3 interfaces	Required	40.2.2
Configure the forwarding mode	Required	40.2.3
Creating VLAN interfaces for common VLANs	Required	40.2.4
Creating superVLAN interfaces and adding VLANs to the superVLAN	Required	40.2.5
Configure IP addresses for VLAN or superVLAN interfaces	Required	40.2.6

Configure an IP address range for VLAN or superVLAN interfaces	Required	40.2.7
Configure the Address Resolution Protocol (ARP) proxy	Required	40.2.8
Display interface configurations	Required	40.2.9
Configure unicast reverse path forwarding (URPF)	Required	40.2.10
Disabling the function of sending Internet Control Message Protocol (ICMP) packets with an unreachable destination host on interfaces	Required	40.2.11

40.2.2 Planning VLANs and Creating L3 Interfaces

For details about VLAN planning, see VLAN configurations.

L3 interfaces are classified into common VLAN interfaces and superVLAN interfaces.

Common VLAN interfaces are created on VLANs and superVLAN interfaces on superVLANs (superVLANs do not exist or contain any port).

40.2.3 Configure the Forwarding Mode

The L3 GPON supports stream forwarding and network topology-based forwarding. In stream forwarding mode, The L3 GPON identifies the failed route or the unreachable destination host route and sends packets to the CPU for further processing. In network topology-based forwarding mode, The L3 GPON directly discards the packets. By default, The L3 GPON works in stream forwarding mode.

Operation	Command	Remarks
Enter the global configuration mode.	system-view	
Set the packet forwarding mode in the system to stream forwarding.	ip def cpu	
Set the packet forwarding mode in the system to network topology-based forwarding.	undo ip def cpu	
Display the configured packet forwarding mode.	display ip def cpu	

40.2.4 Creating VLAN Interfaces for Common VLANs

A VLAN interface needs to be configured for each VLAN that performs L3 forwarding or the VLAN needs to be added to the superVLAN.

Operation	Command	Remarks
Enter the global configuration mode.	system-view	
Create a VLAN interface with the VLAN ID being vid and enter the VLAN interface configuration mode.	interface vlan-interface vid	
Return to the global configuration mode.	quit	

Delete the VLAN interface with the VLAN ID being vid .	undo interface vlan-interface vid	
---	--	--

40.2.5 Creating SuperVLAN Interfaces and Adding VLANs to the SuperVLAN

SuperVLAN interfaces are used for communication between hosts in different VLANs in the same network segment. SuperVLAN interfaces are implemented through the ARP proxy.

Operation	Command	Remarks
Enter the global configuration mode.	system-view	
Create a superVLAN interface with the interface ID being vid and enter the superVLAN interface configuration mode.	interface supervlan-interface vid	
Return to the global configuration mode.	quit	
Delete the superVLAN interface with the interface ID being vid .	undo interface supervlan-interface vid	
Configure sub VLANs for the superVLAN interface.	subvlan vid	
Delete the sub VLANs configured	undo subvlan vid	

for the superVLAN interface.		
------------------------------	--	--

40.2.6 Configure IP Addresses for VLAN or SuperVLAN Interfaces

Each VLAN or superVLAN interface can be configured with a maximum of 32 IP addresses and the IP addresses of VLAN or superVLAN interfaces cannot be in the same network segment. The first IP address of an interface will be automatically selected as the primary IP address. When the primary IP address is deleted, the interface automatically selects another IP address as the primary IP address or a configured IP address can be manually specified as the primary IP address. For example, if the IP address of VLAN interface 1 is 10.10.0.1/16, the IP addresses of other interfaces must not be in the 10.10.0.0/16 network segment (such as 10.10.1.1/24).

Operation	Command	Remarks
Enter the global configuration mode.	system-view	
Enter the VLAN or superVLAN interface configuration mode.	interface vlan-interface <i>vid</i> interface supervlan-interface <i>vid</i>	
Configure an IP address and a mask for the interface.	ip address <i>ipaddress ipaddress mask</i>	
Delete all IP addresses of the interface.	undo ip address	
Delete the specified IP address of	undo ip address <i>ipaddress ipaddress mask</i>	

the interface.		
Configure the primary IP address for the interface.	ip address primary <i>ipaddress</i>	

40.2.7 Configure an IP Address Range for VLAN or SuperVLAN Interfaces

Each VLAN or superVLAN interface can be configured with a maximum of eight IP address ranges. After an IP address range is configured, only the ARP entries within this range can be learnt so as to restrict user access. When a VLAN or superVLAN interface is deleted, relevant configurations are automatically deleted.

For superVLAN interfaces, sub VLANs can be specified at the same time so that the set address range is applicable only to these sub VLANs.

Operation	Command	Remarks
Enter the global configuration mode.	system-view	
Enter the VLAN or superVLAN interface configuration mode.	interface vlan-interface <i><vid></i> interface supervlan-interface <i><vid></i>	
Configure the IP address range supported by this interface, ranging from startip to endip .	ip address range <i>startip endip</i>	
Delete all IP address ranges	undo ip address range	

supported by the interface.		
Delete the specified IP address ranges supported by the interface.	undo ip address range <i>startip endip</i>	
Configure the IP address range for sub VLANs of the superVLAN.	ip address range <i>startip endip vlan vlanid</i> >	
Delete the IP address ranges of the sub VLANs of the superVLAN.	undo ip address range <i>startip endip vlan</i> <i>vlanid</i>	

40.2.8 Configure the ARP Proxy

ARP request packets are broadcast packets and cannot pass through VLANs. If the ARP proxy function is enabled, ARP interaction is supported between hosts in sub VLANs of the same superVLAN. When the ARP proxy is disabled, the hosts of the sub VLANs in the superVLAN interface cannot communicate with each other.

By default, the ARP request packets from all sub VLANs are processed in the preceding manner. In addition, relevant commands can be used to prevent the ARP request packets from a sub VLAN from being broadcast to other sub VLANs when they are processed by the ARP proxy.

Operation	Command	Remarks
Enter the VLAN configuration mode.	vlan <i>vlanid</i>	
Enable the arp-proxy function for the	arp-proxy	

VLAN.		
Disable the arp-proxy function for the VLAN.	undo arp-proxy	
Enable the arp-proxy broadcast function for the VLAN.	arp-proxy broadcast	
Disable the arp-proxy broadcast function for the VLAN.	undo arp-proxy broadcast	
Display the information about the ARP proxy configured in the system.	display arp-proxy	
Display information about the ARP proxy broadcast function configured in the system.	display arp-proxy broadcast	

40.2.9 Display VLAN and SuperVLAN Interface Information

The L3 GPON integrates VLAN interface information and superVLAN interface information.

They can be viewed by running a unified display command.

Operation	Command	Remarks
Display information about the VLAN and superVLAN interfaces currently configured in the system.	display ip interface [[vlan-interface <i>vlanid</i>] [supervlan-interface <i>supervlanid</i>]]	

40.2.10 Configure URPF

URPF aims to prevent network attack behaviors based on source address spoofing. URPF obtains the source address and ingress interface of a packet and uses the source address as the destination address to query the routing table for the matching route. The packet is forwarded if it meets conditions and discarded if it does not meet conditions. Two URPF modes are supported:

Strict mode: In this mode, the source address must exist in the routing table and the egress interface of the source address of the packet is the same as the ingress interface of the packet.

Loose mode: In this mode, the system only checks whether the source address of the packet exists in the unicast routing table. If yes, the packet is forwarded.

Operation	Command	Remarks
Enter the global configuration mode.	system-view	
Enter the VLAN or superVLAN interface configuration mode.	interface vlan-interface <i>vid</i> interface supervlan-interface <i>vid</i>	
Enable URPF for this interface and specify the URPF mode.	urpf { loose strict }	
Disable URPF for this interface.	undo urpf	
Display URPF information in the system.	display urpf	

40.2.11 Disabling the Function of Sending ICMP Packets with an Unreachable Destination Host on Interfaces

To avoid attacks from address scanning software similar to ip-scan, users can disable the function of sending ICMP packets with an unreachable host on interfaces.

Operation	Command	Remarks
Enter the global configuration mode.	system-view	
Enter the VLAN or superVLAN interface configuration mode.	interface vlan-interface <i>vid</i> interface supervlan-interface <i>vid</i>	
Enable the function of this interface for sending ICMP packets with an unreachable destination	ip icmp unreachable	
Disable the function of this interface for sending ICMP packets with an unreachable destination	undo ip icmp unreachable	
Display the configuration of the function of sending ICMP packets with an unreachable destination	display ip icmp unreachable	

Chapter 41 Static Route Configuration

41.1 Static Route Overview

The GPON is an ASIC-based Gigabit intelligent GPON, in which a layer-3 forwarding and routing table is maintained to specify the next hops of routes and relevant information. These routes may be learned dynamically through routing protocols or added manually. A static route is a route to an address or a network segment which is configured manually.

41.2 Configure Static Route

41.2.1 Static Route Configuration List

Configuration Task	Description	Detailed Configuration
Adds a static routing entry	Required	41.2.2
Deletes a static routing entry	Required	41.2.2
Displays a specified routing entry	Optional	41.2.3
Displays an ECMP routing entry	Optional	41.2.3

41.2.2 Adding/Deleting a Static Route

Operation	Command	Remarks
-----------	---------	---------

Enters the global configuration mode.	ip route <i>dst-ip mask gate-ip</i>	
Enters the global configuration mode.	undo ip route dst-ip mask [<i>gate-ip</i>] undo ip route static all	

Notes:

gate-ip: next-hop IP address of a static route, in dotted decimal notation;

dst-ip: destination address of a static route to be added, in dotted decimal notation;

mask: mask of the destination address, in dotted decimal notation.

41.2.3 Display Routing Entries

This command displays the information relevant to the specified routing entry, such as the next-hop address and route type. You can choose to view the routes to a specific destination address, all static routes, and all routes. By default, all routes will be displayed.

Operation	Command	Remarks
Enters the all commands mode.	display ip route [<i>ip-address</i> [<i>mask</i>] static rip ospf]	
Enters the all commands mode.	display ip route ecmp [<i>ip-address</i> [<i>mask</i>] static rip ospf]	

Parameter description:

ip-address: destination address, in dotted decimal notation;

mask: accompany an IP address to specify a destination network segment, in dotted decimal notation;

static: to display all static routing entries;

rip: to display all RIP routing entries;

ospf: to display all OSPF routing entries

Chapter 42 RIP

42.1 RIP Overview

Routing Information Protocol (RIP) is a routing protocol based on the Distance-Vector (D-V) algorithm and has seen wide deployment. It exchanges routing information by sending route update packets over the User Datagram Protocol (UDP) every 30 seconds. If having not received a route update packet from the peer router within 180 seconds, the local router marks all the routes from the peer router as unreachable. If no update packet is received from the peer router yet in 120 seconds after a route is marked as unreachable, the local router deletes the route from its routing table.

RIP uses Hop Count as a routing metric to measure the distance from a destination host. In a RIP network, Hop Count is 0 if a router is directly connected with a network and 1 if a route needs to traverse a router before reaching the destination network, and so on. To restrain the route convergence time, RIP stipulates that Hop Count is an integer ranging from 0 to 15. The distance is considered infinite if Hop Count is larger than or equal to 16. In this case, the destination network or host is unreachable.

RIP has two versions: RIP-1 and RIP-2 (support for plaintext authentication).

To improve routing performance and avoid routing loops, RIP presents the concepts of Split Horizon and Poison Reverse.

Each RIP router manages a routing database, which contains all the destination reachable routing entries on a network. These routing entries include the following information:

Destination address: IP address of a host or network;

Next-hop address: address of a next router on the route to a destination;

Outbound interface: interface from which packets are forwarded;

Metric value: cost of a route from the local router to a destination, which is an integer from 0 to 15.

Timer: time counted from the last modification of a routing entry. The timer is zeroed every time a routing entry is modified.

The RIP startup and operation procedure is described as follows:

Upon RIP startup on a router, the router broadcasts a request packet to its neighboring routers. After receiving the request packet, the neighboring routers (with RIP started) return a response packet which contains the information about their respective local routing tables.

Upon receipt of the response packets, the router that sends the request packet modifies its local routing table.

RIP broadcasts or multicasts the local routing table to its neighboring routers every 30s. The neighboring routers maintain their local routes to select a best route and then broadcast or multicast the modification to their respective neighboring networks, so that the routing update will eventually take effect globally. RIP employs a timeout mechanism to process expired

routes, ensuring that the routes are latest and valid. As an interior routing protocol, RIP helps acquaint routers with the network-wide routing information because of these mechanisms.

RIP has been accepted as one of the standards which regulate the route transmission between a router and a host. L3 GPONes forward IP packets across a LAN the same way as routers. Therefore, RIP is also widely deployed on L3 GPONes. It is applicable to most campus networks and regional networks with a simple structure and good continuity but not recommended in complex large networks.

42.2 Configure RIP

42.2.1 RIP Configuration List

Configuration Task	Description	Detailed Configuration
Enabling RIP	Required	42.2.2
Specifying the IP network segment to run RIP	Required	42.2.3
Configure the Passive interface	Required	42.2.4
Specifying the RIP version for an interface	Required	42.2.5
Configure Default Metric Value	Required	42.2.6
Enabling the Route Aggregation Function	Required	42.2.7
Configure RIP Packet Authentication	Optional	42.2.8
Configure Split Horizon	Optional	42.2.9
Setting an Additional Routing Metric	Optional	42.2.10

Defining a Prefix List	Optional	42.2.11
Configure Route Redistribution	Optional	42.2.12
Configure Route Filtering	Required	42.2.13
Display RIP Configuration	Required	42.2.14

42.2.2 Enabling RIP

Operation	Command	Remarks
Enter the global configuration mode	system-view	
Enters the rip configuration mode.	router rip	
Enters the global configuration mode.	undo router rip	

42.2.3 Specifying the IP Network Segment to Run RIP

By default, an interface does not send or receive RIP packets until the IP network segment to run RIP is specified by the administrator even if RIP is enabled on the interface.

Operation	Command	Remarks
Enter the global configuration mode	system-view	
Enters the rip configuration mode.	router rip	
Runs the command in RIP configuration mode.	network ip-address	
Runs the command in RIP configuration mode.	undo network ip-address	

42.2.4 Configure the Passive interface

System support to block RIP on vlan-interface, which can be implemented by passive-interface command, after using this command, the RIP update packets will not be sent out from this interface.

Operation	Command	Remarks
Enter the global configuration mode	system-view	
Enter RIP configuration mode	router rip	
Configure passive-interface	passive-interface { default vlan-interface vlanid supervlan-interface vlanid }	
Delete passive-interface	undo key passive-interface { default vlan-interface vlanid supervlan-interface vlanid }	

42.2.5 Specifying the RIP Version for an Interface

RIP has two versions: RIP-1 and RIP-2. You can specify the version of the RIP packets to be processed by an interface.

RIP-1 packets are transmitted in broadcast mode. RIP-2 packets may be transmitted in either broadcast or multicast mode. The multicast mode is used by default. In RIP-2, the multicast address is 224.0.0.9.

When the multicast mode is used, non-RIP hosts on the same network will not receive RIP broadcast packets and RIP-1 hosts will not receive or process the RIP-2 routes with a subnet mask. A RIP-2 interface can also receive the RIP-1 broadcast packets.

Operation	Command	Remarks
Enter the global configuration mode	system-view	
Enters the rip configuration mode.	router rip	
Runs the command in vlan-interface configuration mode	version { 1 2 }	
Enter the VLAN-interface or Supervlan-interface configuration mode	interface { vlan-interface supervlan-interface } <i>vlan-id</i>	
Configure RIP receive Version	ip rip receive version { 1 2 [bcast mcast] }	By default, Version is 2mcast
Configure RIP default receive Version	undo ip rip receive version	
Configure RIP send Version	ip rip send version { 1 2 [bcast mcast] }	By default, Version is 2mcast
Configure RIP default send Version	undo ip rip send version	

Notes:

A RIP-1 interface can send and receive RIP-1 broadcast packets. A RIP-2 broadcast interface can receive RIP-1 packets and RIP-2 broadcast packets but not RIP-2 multicast packets. A RIP-2 multicast interface can send and receive RIP-2 multicast packets.

42.2.6 Configure Default Metric Value

This function is to set the default RIP Metric Value .

Operation	Command	Remarks
Enter the global configuration mode	system-view	
Enter RIP configuration mode	router rip	
Configure default metric	default-metric <i>metric</i>	
Delete default metric	undo default-metric	

42.2.7 Enabling the Route Aggregation Function

Route aggregation consolidates the routes on different subnets of a natural network segment into one route with a natural mask and sends the route to another network segment. This function minimizes both the number of entries in a routing table and the amount of information that needs to be exchanged.

RIP-1 sends only the routes with a natural mask, that is, aggregate routes. RIP-2 supports the subnet mask. To broadcast all the subnet routes, you should disable the route aggregation function of RIP-2.

Operation	Command	Remarks
Enter the global configuration mode	system-view	
Enter RIP configuration mode	router rip	
Configure aggregation address	aggregate-address <i>ip-address/mask-length</i>	
Delete aggregation address	undo aggregate-address <i>ip-address/mask-length</i>	

42.2.8 Configure RIP Packet Authentication

RIP-1 does not support packet authentication. A RIP-2 interface, however, can be configured with packet authentication in plaintext or MD5.

Operation	Command	Remarks
Enter the global configuration mode	system-view	
Enter the VLAN-interface or Supervlan-interface configuration mode	interface { vlan-interface supervlan-interface } vlan-id	
Configure MD5 authentication	ip rip authentication mode md5 key-chain <i>key-string</i>	
Configure text authentication	ip rip authentication mode text passwd <i>passwd</i>	
Restores RIP packet authentication.	undo ip rip authentication	

42.2.9 Configure Split Horizon

Split horizon is designed to prevent the routes learned on an interface from being sent through the interface, which avoids routing loops. This function must be disabled in some special situations to ensure correct route advertisement at the cost of advertisement efficiency. By default, split horizon can be enabled on an interface.

Operation	Command	Remarks
Enter the global configuration mode	system-view	
Enter the VLAN-interface or	interface { vlan-interface 	

Supervlan-interface configuration mode	supervlan-interface } <i>vlan-id</i>	
Enable split-horizon function	ip rip split-horizon	By default, it is enabled
Enable split-horizon poisoned-reverse function	ip rip split-horizon poisoned-reverse	By default, it is disabled
Disable split-horizon function	undo ip rip split-horizon	
Disable split-horizon poisoned-reverse function	undo ip rip split-horizon poisoned-reverse	

42.2.10 Setting an Additional Routing Metric

The additional routing metric value is added to RIP routes on an inbound or outbound interface. It does not change the routing metric value of routes in the routing table but adds a designated metric value to the routes to be sent or received by an interface.

Operation	Command	Remarks
Enter the global configuration mode	system-view	
Enter the VLAN-interface or Supervlan-interface configuration mode	interface { vlan-interface supervlan-interface } <i>vlan-id</i>	
Set additional routing metric value for inbound	offset-list { <i>ip-acl-name</i> <i>ip-acl-number</i> } in <i>metric</i> [{ vlan-interface supervlan-interface } <i>vlan-id</i>]	

Delete additional routing metric value for inbound	undo offset-list { <i>ip-acl-name</i> <i>ip-acl-number</i> } in <i>metric</i> [{ vlan-interface supervlan-interface } <i>vlan-id</i>]	
Set additional routing metric value for outbound	offset-list { <i>ip-acl-name</i> <i>ip-acl-number</i> } out <i>metric</i> [{ vlan-interface supervlan-interface } <i>vlan-id</i>]	
Delete additional routing metric value for outbound	undo offset-list { <i>ip-acl-name</i> <i>ip-acl-number</i> } out <i>metric</i> [{ vlan-interface supervlan-interface } <i>vlan-id</i>]	

42.2.11 Defining a Prefix List

A prefix list is identified by a prefix list name, and may contain multiple entries, each of which corresponds to a network prefix identified by a sequence number. The sequence number indicates the matching sequence of a network prefix.

During prefix matching, the GPON checks the entries in ascending order of sequence numbers. If an entry is matched, it is permitted by the current prefix list and will not be matched next time.

Note: By default, if more than one prefix list entry has been defined, at least one permit entry should be available. The deny entries can be defined in advance so that the routes that do not meet the condition are filtered quickly. However, if all the entries are prefixed by deny, no route will be permitted by the address prefix list. You are advised to define an entry permit 0.0.0.0/0 after defining multiple deny entries, so that all the routes meeting the condition are permitted.

Alternatively, you can run the ip prefix-list default command to change the default configuration.

For details, see the description of this command in a command line manual.

Operation	Command	Remarks
Enter the global configuration mode	system-view	
Enter RIP configuration mode	router rip	
Enable sequence-number	ip prefix-list sequence-number	
Disable sequence-number	undo ip prefix-list sequence-number	
Configure prefix-list	ip prefix-list list-name seq sequence-number { deny permit } { any ip-address/mask-length [ge min-prefix-len [le max-prefix-len] }	
Delete prefix-list	undo ip prefix-list list-name [seq sequence-number { deny permit } { any ip-address/mask-length [ge min-prefix-len [le max-prefix-len] }	

42.2.12 Configure Route Redistribution

Routes of protocols other than RIP can be imported into RIP.

In an Ethernet GPON, connected, static, and OSPF routes can be imported into RIP.

Operation	Command	Remarks
Enter the global configuration mode	system-view	
Enter RIP configuration mode	router rip	
Configure Route redistribution	redistribute { babel bgp connected isis kernel ospf rip static } metric metric	

	route-map <i>route-map</i>	
Delete Route redistribution	undo redistribute { babel bgp connected isis kernel ospf rip static }	

42.2.13 Configure Route Filtering

Policies and rules can be configured to filter incoming and outgoing routes based on an address prefix list. In addition, you can configure that only the RIP packets from a specific neighboring Ethernet GPON can be received.

Operation	Command	Remarks
Enter the global configuration mode	system-view	
Enter RIP configuration mode	router rip	
Set distribute-list for inbound	distribute-list { <i>ip-acl-name</i> <i>ip-acl-number</i> prefix <i>prefix-list</i> } in [{ vlan-interface supervlan-interface } <i>vlan-id</i>]	
Delete distribute-list for inbound	undo distribute-list { <i>ip-acl-name</i> <i>ip-acl-number</i> prefix <i>prefix-list</i> } in [{ vlan-interface supervlan-interface } <i>vlan-id</i>]	
Set distribute-list for outband	distribute-list { <i>ip-acl-name</i> <i>ip-acl-number</i> prefix <i>prefix-list</i> } out [{ vlan-interface supervlan-interface } <i>vlan-id</i>]	
Delete distribute-list for outband	undo distribute-list { <i>ip-acl-name</i>	

	<i>ip-acl-number</i> prefix prefix-list } out [{ vlan-interface supervlan-interface } <i>vlan-id</i>]	
--	---	--

42.2.14 Display RIP Configuration

Operation	Command	Remarks
Displays the RIP packet statistics information.	display ip rip	
Displays the RIP interface configuration, such as the version and authentication information.	display ip rip interface	
Displays RIP routing tables.	display ip route rip	

Chapter 43 OSPF

43.1 OSPF Overview

Open Shortest Path First (OSPF) is an interior routing protocol, which is developed by IETF based on the link state detection and shortest path first technologies. In an IP network, OSPF dynamically discovers and advertise routes by collecting and transmitting the link states of autonomous systems (ASs). It supports interface-based packet authentication for purposes of route calculation security and employs IP multicast to send and receive packets.

Each OSPF router maintains a database that describes the topological structure of an AS. The database is a collection of link-state advertisements (LSAs) of all the routers. Every router always broadcasts the local state information across the entire AS. If two or more routers exist in a multi-access network, a designated router (DR) and a backup designated router (BDR) must be elected. The DR is responsible for broadcasting the LSAs of the network. With a DR, a multi-address access network may require less neighbor relationships to be established between routers. OSPF allows an AS to be divided into areas, between which routing information is further abstracted. As a result, smaller network bandwidth will be occupied.

OSPF uses four types of routes, which are listed in order of priority as follows:

Intra-area routes

Inter-area routes

Type 1 external routes

Type 2 external routes

Intra-area and inter-area routes describe the network structure of an AS, while external routes depict how routes are distributed to destinations outside an AS. Generally, type 1 external routes are based on the information imported by OSPF from other interior routing protocols and comparable to OSPF routes in routing cost; type 2 external routes are based on the information imported by OSPF from exterior routing protocols and the costs of such routes are far greater than those of OSPF routes. Therefore, route calculation only takes the external costs into consideration.

Based on the link state database (LSDB), each router builds a shortest path tree with itself as the root, which presents the routes to every node in an AS. An external route emerges as a leaf node and can also be marked by the router that broadcasts the external route so that additional information about an AS is recorded.

All the OSPF areas are connected to the backbone area, which is identified by 0.0.0.0. OSPF areas must be logically continuous. To achieve this end, virtual connection is introduced to the backbone area to ensure the logical connectivity of areas even if they are physically separated.

All the routers in an area must accept the parameter settings of the area. Therefore, the configuration of routers in the same area must be performed in consideration of the parameter settings of the area. A configuration error may lead to the failure of information transfer between adjacent routers and even routing failures or routing loops.

43.2 Configure OSPF

43.2.1 OSPF Configuration List

Configuration Task	Description	Detailed Configuration
Enable OSPF	Required	43.2.2
Configure OSPF Parameter	Required	43.2.3
Configure OSPF Interface	Required	43.2.4
Configure OSPF Area	Required	43.2.5

43.2.2 Enable OSPF

Operation	Command	Remarks
Enter the global configuration mode	system-view	
Enters global configuration mode.	router ospf	
Enters global configuration mode.	undo router ospf	

43.2.3 Configure OSPF Parameter

OSPF divides an AS into different areas, based on which routers are logically classified into different groups. Area border routers (ABRs) may belong to different areas. A network segment belongs to only one area, that is, the homing area of an OSPF interface must be specified. An area is identified by an area ID. Routes between areas are transmitted by ABRs. In addition, all the routers in an area must unanimously accept the parameter settings of the area. Therefore, the configuration of routers in the same area must be performed in

consideration of the parameter settings of the area. A configuration error may lead to the failure of information transfer between adjacent routers and even routing failures or routing loops.

Operation	Command	Remarks
Enter the global configuration mode	system-view	
Enters global configuration mode.	router ospf	
Enters global configuration mode.	router id <i>router-id</i>	
Enters global configuration mode.	undo router id	
Runs the command in OSPF configuration mode.	network <i>ipaddress wildcard-mask area</i> <i>area-id</i>	
Runs the command in OSPF configuration mode.	undo network <i>ipaddress wildcard-mask</i> area <i>area-id</i>	
Configures the authentication type for an area.	area <i>area-id authentication</i> [message-digest]	
Restores the authentication type of an interface to no authentication.	undo area <i>area-id authentication</i>	

43.2.4 Configure OSPF Interface

OSPF calculates routes based on the topological structure of the network adjacent to the local router. Each router describes the topology of its adjacent network and transmits it to the other routers. According to the link layer protocol, OSPF classifies networks into the following four types:

Broadcast networks: When Ethernet or FDDI is used as the link layer protocol, OSPF considers that the network type is broadcast by default.

Non Broadcast MultiAccess (NBMA) networks: When ATM is used as the link layer protocol, OSPF considers that the network type is NBMA by default.

Point-to-Multipoint networks: This network type will be considered as default in no case. It is always a substitute of other network types through forcible change. An NBMA network that is not fully meshed is often changed to a point-to-multipoint network.

Point-to-Point networks: When PPP, LAPB, or POS is used as the link layer protocol, OSPF considers that the network type is Point-to-Point by default.

The ATM network is a typical NBMA network. A polling interval can be configured to specify the interval of sending Hello packets before a router establishes a neighbor relationship with its neighboring router.

On a broadcast network incapable of multi-address access, you can configure the interface type to nonbroadcast.

If some routers are not directly reachable on an NBMA network, you can configure the interface type to point-to-multipoint.

If a router has only one peer router on an NBMA network, you can set the interface type to point-to-point.

The differences between an NBMA network and a point-to-multipoint network are as follows:

In OSPF, an NBMA network refers to a non-broadcast multi-access network that is fully meshed. A point-to-multipoint network may not be fully meshed.

A DR and a BDR must be elected on an NBMA network but are not involved on a point-to-multipoint network.

NBMA is a default network type. For example, if the link layer protocol is ATM, OSPF considers that the network type is NBMA by default no matter whether the network is fully meshed. Point-to-multipoint is not a default network type. No link layer protocol is viewed as a point-to-multipoint protocol. You can use this network type through a forcible change. An NBMA network that is not fully meshed is often changed to a point-to-multipoint network.

On an NBMA network, packets are transmitted in unicast mode, which requires you to configure neighbor relationship manually. On a point-to-multipoint network, packets are transmitted in multicast mode.

An Ethernet GPON uses Ethernet as the link layer protocol, so OSPF regards that the network type is broadcast. Do not change the network type of an Ethernet GPON at discretion.

Operation	Command	Remarks
Enter the global configuration mode	system-view	
Enter the VLAN-interface or Supervlan-interface configuration mode	interface { vlan-interface supervlan-interface } vlan-id	
Sets the network type of an	ip ospf network { broadcast 	

interface.	non-broadcast point-to-multipoint point-to-point }	
Restores the network type of an interface to the default value.	undo ip ospf network	
Sets the cost of sending packets through a VLAN interface.	ip ospf cost <i>cost</i>	
Restores the packet sending cost of a VLAN interface to the default value.	undo ip ospf cost	
Sets the priority of an interface in DR election.	ip ospf priority <i>value</i>	
Restores the default priority of an interface.	undo ip ospf priority	
Sets the interval of sending Hello packets for an interface.	ip ospf hello-interval <i>seconds</i>	
Restores the interval of sending Hello packets for an interface to the default value.	undo ip ospf hello-interval	
Sets the timeout time of the neighboring router.	ip ospf dead-interval <i>seconds</i>	
Restores the timeout time of the	undo ip ospf dead-interval	

neighboring router to the default value.		
Sets the interval of LSA retransmission between two adjacent routers.	ip ospf retransmit-interval <i>seconds</i>	
Restores the interval of LSA retransmission between two adjacent routers to the default value.	undo ip ospf retransmit-interval	
Sets the time for sending a link state update packet.	ip ospf transmit-delay <i>seconds</i>	
Restores the time for sending a link state update packet to the default value.	undo ip ospf transmit-delay	
Sets the authentication type	ip ospf authentication [<i>null</i> <i>ipaddress</i> message-digest [<i>ipaddress</i>]]	
Restores the authentication type	undo ip ospf authentication [<i>ipaddress</i>]	
Sets a password for plaintext authentication.	ip ospf authentication-key <i>password</i> [<i>ipaddress</i>]	
Disables plaintext authentication.	undo ip ospf authentication-key [<i>ipaddress</i>]	

Sets a password for MD5 authentication.	ip ospf message-digest-key <i>key-id</i> md5 <i>key</i> [<i>ipaddress</i>]	
Disables MD5 authentication.	undo ip ospf message-digest-key <i>key-id</i> [<i>ipaddress</i>]	

43.2.5 Configure OSPF Area

A stub area is a special LSA area in which ABRs do not distribute the external routes they have received. In stub areas, both the size of routing tables and the amount of the routing information are drastically reduced.

Any area that meets certain conditions can be configured into a stub area. Generally, a stub area is located at the border of an AS. It may be a non-backbone area with only one ABR or a non-backbone area with multiple ABRs between which no virtual connection is configured.

To make a stub area reachable for other ASs, the ABR in the stub area generates a default route (0.0.0.0) and advertises it to non-ABR routers in this area.

When Configure a stub area, note the following points:

- A backbone area cannot be a stub area and a virtual connection is not allowed in a stub area.

- All the routers in a stub area must be configured to indicate that they are located in a stub area.

- No ASBR is allowed in a stub area, that is, routes from outside the AS where the stub area resides cannot be advertised within the stub area.

Operation	Command	Remarks
Enter the global configuration mode	system-view	
Enters global configuration mode.	router ospf	
Configures a stub area.	area area-id stub [no-summary]	
Cancels the stub area configuration.	undo area area-id stub [no-summary]	
Configures the cost of the default route to a stub area.	area area-id default-cost cost	
Cancels the cost configuration for the default route to a stub area.	undo area area-id default-cost	
Configures an NSSA area.	area area-id nssa [no-summary]	
Cancels the NSSA area configuration.	undo area area-id nssa [no-summary]	
Configures the cost of the default route to an NSSA area.	area area-id default-cost cost	
Cancels the cost configuration for the default route to an NSSA area.	undo area area-id default-cost	
Configures route aggregation in an OSPF area.	area area-id range ip-address/mask-length [advertise notadvertise] [substitute p-address/mask-length]	
Removes route aggregation in an OSPF area.	undo area area-id range ip-address/mask-length [substitute p-address/mask-length]	
Creates and configures a virtual	area area-id virtual-link router-id [{ hello-interval	

connection.	<i>seconds</i> retransmit-interval <i>seconds</i> transmit-delay <i>seconds</i> dead-interval <i>seconds</i> { authentication-key <i>password</i> message-digest-key <i>keyid md5 key</i> } *]	
Cancels a virtual connection.	undo area <i>area-id</i> virtual-link <i>router-id</i>	
Imports routes of other protocols into OSPF.	redistribute { babel bgp connected isis kernel rip static } [metric <i>metric-value</i>] [metric-type { 1 2 }] [route-map <i>map-name</i>]	
Disables the import of routes of other protocols into OSPF.	undo redistribute { babel bgp connected isis kernel rip static } [metric <i>metric</i>] [metric-type { 1 2 }] [route-map <i>map-name</i>]	
Imports the default route to OSPF.	default-information originate [always] [metric <i>metric-value</i>] [metric-type { 1 2 }] [route-map <i>map-name</i>]	
Disables the import of the default route.	undo default-information originate [always] [metric <i>metric-value</i>] [metric-type { 1 2 }] [route-map <i>map-name</i>]	
Configures a default metric value for reception of external routes.	default-metric <i>metric-value</i>	
Cancels the default metric value configuration for reception of	undo default-metric	

external routes.		
Configures distribute-list	distribute-list { <i>ip-acl-name</i> <i>ip-acl-number</i> } out { babel bgp connected isis kernel rip static }	
Delete distribute-list	undo distribute-list { <i>ip-acl-name</i> <i>ip-acl-number</i> } out { babel bgp connected isis kernel rip static }	
Enter the VLAN-interface or Supervlan-interface configuration mode	interface { vlan-interface supervlan-interface } <i>vlan-id</i>	
Enables BFD for link state monitoring.	ip ospf bfd	
Disables BFD.	undo ip ospf bfd	

Chapter 44 BGP

44.1 BGP Overview

Border Gateway Protocol (BGP) is a dynamic routing protocol deployed between autonomous systems (ASs). It automatically exchanges loop-free routing information between ASs and builds up the topological structure of ASs through exchange of network reachability information with the AS Path attribute.

BGP normative references include RFC1105 (BGP-1), RFC1163 (BGP-2), RFC1267 (BGP-3), RFC1771 (BGP-4), and RFC4271 (BGP-4). RFC1771 has seen the widest application and RFC4271 is the latest issue. BGP is suitable for a distributed network and supports Classless InterDomain Routing (CIDR). With BGP, users can customize policies. BGP-4 is becoming a matter-of-factor standard for Internet exterior routing protocols. BGP is usually deployed between ISPs.

BGP has the following features:

Interior routing protocols such as OSPF and RIP are designed to discover and calculate routes. As an exterior routing protocol, BGP focuses on control of route distribution and selection of the best route.

The AS Path attribute is added to BGP routes to eliminate the routing loop problem.

With TCP as the transport layer protocol, BGP presents better protocol reliability.

Support for CIDR is a significant characteristic of BGP-4 compared with BGP-3. The CIDR technology does not categorized IP addresses into class A, class B, and class C IP addresses. For example, 192.168.0.0 (255.255.0.0) is naturally an invalid class C IP address. This IP address, however, is expressed as 192.168.0.0/16 in CIDR and becomes a valid network address. /16 indicates that the subnet mask is composed of the first 16 bits counted from the left of the IP address. CIDR also simplifies route aggregation, which is a process of consolidating several different routes. With the route aggregation technology, multiple routes are advertised as one route, which reduces the overhead of BGP tables and network bandwidth usage.

In the case of route updates, BGP transmits only incremental routes and substantially reduces the bandwidth used by BGP route transmission. Therefore, BGP is appropriate when a large number of routes need to be transmitted on Internet.

In consideration of management and security, each AS expects to control its incoming and outgoing routes. BGP-4 provides abundant routing policies for flexible route filtering and selection. In addition, BGP-4 is easy to expand and conducive to network development.

BGP runs on a specific router as an upper-layer protocol. Upon startup of BGP, the BGP router sends the entire BPG table to its peer for routing information exchange and then only Update messages are exchanged between them for processing of changed routes. BGP detects the connection between routers by sending and receiving Keepalive messages.

The router sending a BGP message is called the BGP speaker, which constantly receives or generates new routing information and advertises it to other BGP speakers. After receiving a

new route advertisement from another AS, the BGP speaker distributes the route advertisement to all the other BGP speakers in the same AS if the route is better than the current one or has not been received ever. If two BGP speakers are exchanging messages, they call each other the peer.

BGP runs on a router in either of the following modes:

Internal BGP (IBGP)

External BGP (EBGP)

BGP is regarded as IBGP when deployed within an AS and as EBGP when deployed between ASs.

BGP running is driven by messages, which are classified as follows:

Open message

Update message

Notification message

Keepalive message

An Open message is the first message to be sent after setup of a TCP connection and used to establish a BGP peer relationship. A Notification message is sent when there is an error. A Keepalive message is sent to detect the validity of a connection. As the most important message in BGP, an Update message is transmitted between BGP peers for routing information exchange. It consists of three parts at most: unreachable route, path attributes,

and Network Layer Reachability Information (NLRI).

44.2 Configure BGP

44.2.1 BGP Configuration List

Configuration Task	Description	Detailed Configuration
Enable BGP	Required	44.2.2
Configure BGP peers	Required	44.2.3
Configure BGP Parameters	Required	44.2.4
Monitoring and Maintain BGP	Required	44.2.5

44.2.2 Enable BGP

Operation	Command	Remarks
Enter the global configuration mode	system-view	
Runs the command in global configuration mode.	router bgp <i>as-number</i>	
Runs the command in global configuration mode.	undo router bgp <i>as-number</i>	
Configures the local route to be advertised by BGP.	network <i>ip-address</i> [mask <i>address-mask</i>]	
Cancels the local route to be advertised by BGP.	undo network <i>ip-address</i> [mask <i>address-mask</i>]	

Establishes a neighbor relationship and sets the AS number of the peer.	neighbor <i>neighbor-name</i> peer-group	
Cancels neighbor relationship	undo neighbor <i>neighbor-name</i> peer-group	

44.2.3 Configure BGP Peers

Operation	Command	Remarks
Enter the global configuration mode	system-view	
Runs the command in global configuration mode.	router bgp <i>as-number</i>	
Establishes a neighbor relationship and sets the AS number of the peer.	neighbor { <i>neighbor-address</i> <i>neighbor-name</i> } remote-as <i>as-number</i>	
Deletes the established neighbor relationship.	undo neighbor { <i>neighbor-address</i> <i>neighbor-name</i> } remote-as	
Configures peer-group member	neighbor <i>neighbor-address</i> peer-group <i>neighbor-name</i>	
Delete peer-group member	undo neighbor <i>neighbor-address</i> peer-group <i>neighbor-name</i>	
Configures that a connection can be established with an EBGP peer on an indirectly-connected	neighbor { <i>neighbor-address</i> <i>neighbor-name</i> } ebgp-multihop [<i>ttl</i>]	

network.		
Configures that a connection can be established only with an EBGP peer on a directly-connected network.	undo neighbor { <i>neighbor-address</i> <i>neighbor-name</i> } ebgp-multihop	
Configures the Keepalive interval and hold timer of a BGP peer.	neighbor { <i>neighbor-address</i> <i>neighbor-name</i> } timers <i>keepalive-interval</i> <i>hold-time</i>	
Restores the Keepalive interval and hold timer of a BGP peer to the default values.	undo neighbor { <i>neighbor-address</i> <i>neighbor-name</i> } timers	
Configures the interval a BGP peer waits before sending a route update message.	neighbor { <i>neighbor-address</i> <i>neighbor-name</i> } advertisement-interval <i>seconds</i>	
Restores the interval a BGP peer waits before sending a route update message to the default value.	undo neighbor { <i>neighbor-address</i> <i>neighbor-name</i> } advertisement-interval	
Configures that its own address is used as the next hop during route advertisement.	neighbor { <i>neighbor-address</i> <i>neighbor-name</i> } next-hop-self	
Cancels the configuration that its	undo neighbor { <i>neighbor-address</i>	

own address is used as the next hop during route advertisement.	<i>neighbor-name</i> } next-hop-self	
Configures an IP ACL-based route filtering policy for the peer.	neighbor { <i>neighbor-address</i> <i>neighbor-name</i> } distribute-list { <i>ip-acl-name</i> <i>ip-acl-number</i> } { in out }	
Deletes an IP ACL-based route filtering policy of the peer.	undo neighbor { <i>neighbor-address</i> <i>neighbor-name</i> } distribute-list { <i>ip-acl-name</i> <i>ip-acl-number</i> } { in out }	
Configures an AS Path-based route filtering policy for the peer.	neighbor { <i>neighbor-address</i> <i>neighbor-name</i> } filter-list <i>aspath-list-number</i> { in out }	
Deletes an AS Path-based route filtering policy for the peer.	undo neighbor { <i>neighbor-address</i> <i>neighbor-name</i> } filter-list <i>aspath-list-number</i> { in out }	
Configures an IP-Prefix list route filtering policy for the peer.	neighbor { <i>neighbor-address</i> <i>neighbor-name</i> } prefix-list <i>list-name</i> { in out }	
Deletes an IP-Prefix list route filtering policy for the peer.	undo neighbor { <i>neighbor-address</i> <i>neighbor-name</i> } prefix-list <i>list-name</i> { in out }	

44.2.4 Configure BGP Parameters

Operation	Command	Remarks
Enter the global configuration mode	system-view	
Runs the command in global configuration mode.	router bgp <i>as-number</i>	
Runs the command in BGP configuration mode.	timers bgp <i>keepalive-interval hold-time</i>	
Restores the default value of the timer.	undo timers bgp	
Disable sending connection request packet	neighbor { <i>neighbor-address</i> <i>neighbor-name</i> } passive	
Enable sending connection request packet	undo neighbor { <i>neighbor-address</i> <i>neighbor-name</i> } passive	
Shutdown the neighbor connection	neighbor { <i>neighbor-address</i> <i>neighbor-name</i> } shutdown	
Open the neighbor connection	undo neighbor { <i>neighbor-address</i> <i>neighbor-name</i> } shutdown	
Configures a local priority.	bgp default local-preference <i>value</i>	
Restores the default local priority.	undo bgp default local-preference	
Compares the MED values of neighbors from different ASs.	bgp always-compare-med	
Compares the MED values of neighbors from different ASs.	undo bgp always-compare-med	

Configures local route aggregation.	aggregate-address { <i>ip-address mask</i> <i>ip-address/mask-length</i> } [summary-only] [as-set]	
Disables local route aggregation.	undo aggregate-address { <i>ip-address mask</i> <i>ip-address/mask-length</i> }	
Imports IGP routes into BGP.	redistribute { babel connected isis kernel ospf rip static } [metric <i>metric</i>] [route-map <i>route-map</i>]	
Cancels the import of IGP routes into BGP.	undo redistribute { babel connected isis kernel ospf rip static }	

44.2.5 Monitoring and Maintain BGP

Operation	Command	Remarks
Displays the detailed information of BGP peers.	display ip bgp neighbors <i>neighbor-address</i> [vpn-instance <i>instance</i>]	
Displays the brief information of BGP peers.	display ip bgp summary [vpn-instance <i>instance</i>]	

Chapter 45 BFD

45.1 BFD Overview

Bidirectional Forwarding Detection (BFD) periodically checks the status of the peers of a session and notifies a routing protocol of a fault if any immediately. Then the routing protocol responds with a fast reroute action. Generally, the BFD interval is shorter than 1s and therefore the convergence time of routing protocols is reduced. For this reason, BFD can help routing protocols such as OSPF, RIP, and BGP to detect the reachability of neighbors or link failures, which realizes fast reroute and ensures link reliability.

45.2 Configure BFD

45.2.1 BFD Configuration List

Configuration Task	Description	Detailed Configuration
Enable BFD	Required	45.2.2
Configure BFD Parameters and Mode	Optional	45.2.3
Display and Maintain BFD Configurations	Optional	45.2.4

45.2.2 Enable BFD

Operation	Command	Remarks
Enter the global configuration mode	system-view	

Enable bfd function	bfd enable	
Disable bfd function	bfd disable	
Enter the VLAN-interface or Supervlan-interface configuration mode	interface { vlan-interface supervlan-interface } <i>vlan-id</i>	
Enable bfd function	ip ospf bfd	
Disable bfd function	undo ip ospf bfd	OSPF BFD is disabled by default. Currently, only OSPF BFD is supported.

45.2.3 Configure BFD Parameters and Mode

Operation	Command	Remarks
Enter the global configuration mode	system-view	
Enter the VLAN-interface or Supervlan-interface configuration mode	interface { vlan-interface supervlan-interface } <i>vlan-id</i>	
Configures the desired minimum transmission interval of BFD.	bfd min-transmit-interval <i>interval</i>	
Restores the desired minimum	undo bfd min-transmit-interval	The default value

transmission interval of BFD to the default value.		is 400 ms.
Configures the minimum request receiving interval of BFD.	bfd min-receive-interval <i>interval</i>	
Restores the minimum request receiving interval of BFD to the default value.	undo bfd min-receive-interval	The default value is 400 ms.
Configures the BFD multiplier.	bfd detect-multiplier <i>value</i>	
Restores the BFD multiplier to the default value.	undo bfd detect-multiplier	
Configures whether BFD sessions can enter the demand mode.	bfd demand on	
Restores the configuration of whether BFD sessions can enter the demand mode to the default value.	bfd demand off	The default value is off (not allowed).
Configures the initial mode of BFD sessions.	bfd session init-mode active	The default value is active.
Restores the initial mode of BFD sessions to the default value.	bfd session init-mode passive	
Clears the statistics of the sent and received packets in BFD sessions	clear bfd session statistics	

through an interface.		
-----------------------	--	--

Notes:

value: desired minimum packet transmission interval of an interface. It ranges from 200 to 1000 ms and is 400 ms by default.

Packet transmission interval = max(Desired minimum transmission interval, Minimum receiving interval) x a percentage (from 70% to 90%)

45.2.4 Display and Maintain BFD Configurations

Operation	Command	Remarks
Views the information of all the BFD sessions.	display bfd session [verbose]	
Views the BFD configuration of each interface.	display bfd interface [verbose]	

Chapter 46 VRRP

46.1 VRRP Overview

On a TCP/IP network, routes must be configured between two devices without a physical connection to ensure their communication. Currently, routes can be specified through dynamic learning by means of a routing protocol (such as RIP and OSPF) or static configuration. It is impractical to run a dynamic routing protocol on every terminal. Most client operating systems do not support the dynamic routing and they are still under the restraint of management overhead, convergence degree, and security even if they can be configured with a routing protocol. Usually, static routes are configured for IP terminals by specifying one or more default gateways. Static routing simplifies network management and reduces the communication overhead of terminals. However, if a GPON functioning as a default gateway is damaged, the communication in which the GPON is used as the next-hop host will inevitably be interrupted. A terminal will not be GPONed to a new gateway even if there are multiple default gateways until it is restarted. Virtual Router Redundancy Protocol (VRRP) can rectify the defect of static routing.

VRRP introduces two pairs of concepts: VRRP GPON and virtual GPON, master GPON and backup GPON. A VRRP GPON is a real GPON where VRRP runs, while a virtual GPON is a logical GPON created by VRRP. A group of VRRP GPONes form a virtual GPON, which is also called a backup group. The virtual GPON is represented as a logical GPON with a unique

IP address and MAC address. GPONs in a VRRP group are classified into master GPONs and backup GPONs. A VRRP group has only one master GPON and one or more backup GPONs. VRRP selects a master GPON from the GPON group. The master GPON responds to ARP requests and forwards IP packets, and the other GPONs are standby as a backup. If the master GPON is faulty due to some reason, a backup GPON will become the master one within several seconds. Such a switch over is completed very quickly without requiring you to change the IP address or MAC address, and therefore it is transparent to terminal users.

46.2 Configure VRRP

46.2.1 VRRP Configuration List

Configuration Task	Description	Detailed Configuration
Enable VRRP	Required	46.2.2
Configure VRRP Parameters	Optional	46.2.3
Displays and Maintain VRRP Configurations	Optional	46.2.4

46.2.2 Enable VRRP

The `ip vrrp vrid vip` command is used to assign a virtual GPON (or a backup group) an IP address on the local network segment. The `no` form of this command is used to remove the virtual IP address of a backup group from the virtual IP address list.

Operation	Command	Remarks
Enter the global configuration mode	system-view	

Enter the VLAN-interface or Supervlan-interface configuration mode	interface { vlan-interface supervlan-interface } <i>vlan-id</i>	
Configures VRRP virtual IP address	ip vrrp <i>vrid vip</i>	
Deletes VRRP virtual IP address	undo ip vrrp <i>vrid [vip]</i>	

Description:

The backup group number ranges from 1 to 255. A virtual address can be an unassigned IP address on the network segment where the backup group resides or the IP address of an interface belonging to the backup group. A maximum of 255 backup groups can be configured. The IP address of the GPON itself can be configured. In this case, the GPON is known as an IP address owner. When the first IP address is assigned to a backup group, VRRP creates the backup group. Other virtual IP addresses configured for the backup group will only be added to the virtual IP address list of the backup group. A backup group can be configured with eight IP addresses at most. A backup group will be deleted together with the last virtual IP address. That is, this backup group does not exist on the interface and all configurations of the backup group will no longer take effect.

46.2.3 Configure VRRP Parameters

The master GPON in a backup group will not be replaced unless it is faulty even if another GPON is configured with a higher priority later. However, if the preemption mechanism is applied, a GPON will become the master GPON if its priority is higher than that of the master

GPON and the original master GPON will become a backup GPON accordingly. When preemption is enabled, you can set the delay of preemption. Then a backup GPON becomes master after the delay. A backup GPON will become the master GPON if it does not receive a packet from the original master GPON. However, if a network has unstable performance, a backup GPON may not receive a packet due to network congestion but the master GPON is still working properly. In this situation, the backup GPON will receive a packet from the master GPON after waiting a short time. As a result, frequent switch overs can be avoided. The delay ranges from 0 to 255 seconds.

The master GPON sends VRRP packets within the VRRP backup group at an interval specified by `adver_interval` to indicate that it is working properly. If the backup GPON does not receive a VRRP packet from the master GPON within a period of time specified by `master_down_interval`, it regards that the master GPON is faulty and changes its state to Master.

You can modify the value of `adver_interval` by running a timer setting command. The value of `master_down_interval` is three times that of `adver_interval`. An abnormal switch over may occur in the event of extremely large traffic or variance in timer settings between GPONes. To solve this problem, you can set `adver_interval` to a greater value or modify the preemption delay. The value of `adver_interval` is in the unit of second.

Operation	Command	Remarks
Enter the global configuration mode	system-view	
Enter the VLAN-interface or	interface { vlan-interface 	

Supervlan-interface configuration mode	supervlan-interface } <i>vlan-id</i>	
Configures VRRP priority	vrrp priority <i>vridpriority</i>	The priority ranges from 0 to 255. A larger value indicates a higher priority.
Restores the VRRP priority r to the default value.	undo vrrp priority <i>vrid</i>	By default, it is 100
Configures VRRP preempt mode	vrrp preempt <i>vrid</i>	
Restores the preempt mode to the default value.	undo vrrp preempt <i>vrid</i>	By default, preempt is disabled
Configures VRRP preempt delay time	vrrp preempt <i>vrid</i> [delay <i>delay</i>]	
Restores the delay time to the default value.	undo vrrp preempt <i>vrid</i>	By default, it is 0 second
Configures VRRP advertise interval time	vrrp timer <i>vrid</i> <i>adver-interval</i>	
Restores the advertise interval to the default value.	undo vrrp timer <i>vrid</i>	By default, it is 1 second

Configures VRRP track function	vrrp vrid track track-entry [reduced priority]	By default, it is disabled
Deletes VRRP track function	undo vrrp vrid track vrid { all track-entry }	

Note: The priority of the IP address owner cannot be changed and is always 255.

Parameter description:

vrid: virtual group ID, in the range of 1 to 255;

vlan-id: ID of the VLAN to which a VLAN interface belongs;

supervlan-id: ID of the super VLAN to which a superVLAN interface belongs;

pri-value: priority to be reduced if the interface under monitoring is down.

46.2.4 Displays and Maintain VRRP Configurations

Operation	Command	Remarks
Runs the command in any mode.	display vrrp [vlan-interface supervlan-interface vlan-id [vrid]	

Chapter 47 DLF-Control

47.1 DLF-Control Overview

Unknown packets are classified into unknown unicast packets and unknown multicast packets.

Unknown unicast packets are packets that cannot find the destination MAC addresses in the MAC table.

Unknown multicast packets are packets that cannot find the destination MAC addresses of the multicast packets in the multicast MAC table.

47.2 Configure DLF-Control

47.2.1 DLF-Control Configuration List

Configuration Task	Description	Detailed Configuration
Configure DLF-forward unicast	Required	47.2.2
Configure DLF-forward unicast	Optional	47.2.3
Displays and Maintain DLF-forward Configurations	Optional	47.2.4

47.2.2 Configure DLF-forward unicast

Operation	Command	Remarks
Enter the global configuration mode	system-view	
Enter interface configuration mode	interface ethernet <i>interface-num</i>	

Enable dlf-forward unicast	dlf-forward unicast	Enabled by default.
Disable dlf-forward unicast	undo dlf-forward unicast	

47.2.1 Configure DLF-forward multicast

Operation	Command	Remarks
Enter the global configuration mode	system-view	
Enable dlf-forward multicast	dlf-forward multicast	Enabled by default.
Disable dlf-forward multicast	undo dlf-forward multicast	

47.2.2 Displays and Maintain DLF-forward Configurations

Operation	Command	Remarks
Displays the unicast dlf-forward control	display dlf-forward interface [ethernet interface-num]	
Displays the multicast dlf-forward control	display dlf-forward global	

Chapter 48 SLF-Control

48.1 SLF-Control Overview

Whether the GPON forwards the packet with an unknown source MAC address requires the network administrator to plan according to the security policy. The GPON defaults to forward the packet with an unknown source MAC address. You can disable the forwarding function of packet with an unknown source MAC address by setting the commands. After disable this function, if the device receives the packets, it will check whether the source mac exists in the mac table. If it does not exist, the packets will be discarded, that is, the GPON only forwards the packet with the source MAC address being known.

48.2 Configure SLF-Control

48.2.1 SLF-Control Configuration List

Configuration Task	Description	Detailed Configuration
Configure SLF-forward unicast	Required	48.2.2
Displays and Maintain SLF-forward Configurations	Optional	48.2.3

48.2.2 Configure SLF-forward unicast

Generally, this function is used when the MAC address learning function is disabled or MAC address limit function is disabled.

Operation	Command	Remarks
Enter the global configuration mode	system-view	
Enter interface configuration mode	interface ethernet <i>interface-numt</i>	
Enable Slf-forward	slf-forward	
Disable Slf-forward	undo slf-forward	Disabled by default.

48.2.3 Displays and Maintain SLF-forward Configurations

Operation	Command	Remarks
Displays the slf-forward control	display slf-forward interface [ethernet <i>interface-num</i>]	

Chapter 49 BPDU-Discard

49.1 BPDU-Discard Overview

The Discard-bpdu function is used to drop spanning tree message. If the device does not want to receive BPDU message from other networks and cause the GPON spanning tree to vibrate. This function can be opened.

This function is usually enabled on the edge port.

The Discard-BPDU function is disabled by default. Global configuration and port configuration are mutually exclusive: globally, all ports are enabled. If you only need to enable certain designated ports and other ports are not enabled, you need not configure them globally to directly enter the specified port enabling function.

49.2 Configure BPDU-Discard

49.2.1 BPDU-Discard Configuration List

Configuration Task	Description	Detailed Configuration
Configure BPDU-Discard	Required	49.2.2
Displays and Maintain BPDU-Discard Configurations	Optional	49.2.3

49.2.2 Configure BPDU-Discard

Operation	Command	Remarks
-----------	---------	---------

Enter the global configuration mode	system-view	
Enter interface configuration mode	interface ethernet <i>interface-num</i>	
Enable BPDU-Discard	bpdu-discard	
Disable BPDU-Discard	undo bpdu-discard	Disabled by default.

49.2.3 Displays and Maintain BPDU-Discard Configurations

Operation	Command	Remarks
Displays the BPDU-Discard configuration	display bpdu-discard interface [ethernet <i>interface-num</i>]	

Chapter 50 BPDU-Tunnel

50.1 BPDU-Tunnel Overview

L2TP (Layer 2 Tunneling Protocol) is a Layer 2 tunneling technology, L2TP enables Layer 2 protocol packets from geographically dispersed customer networks to be transparently transmitted over specific tunnels across a service provider network.

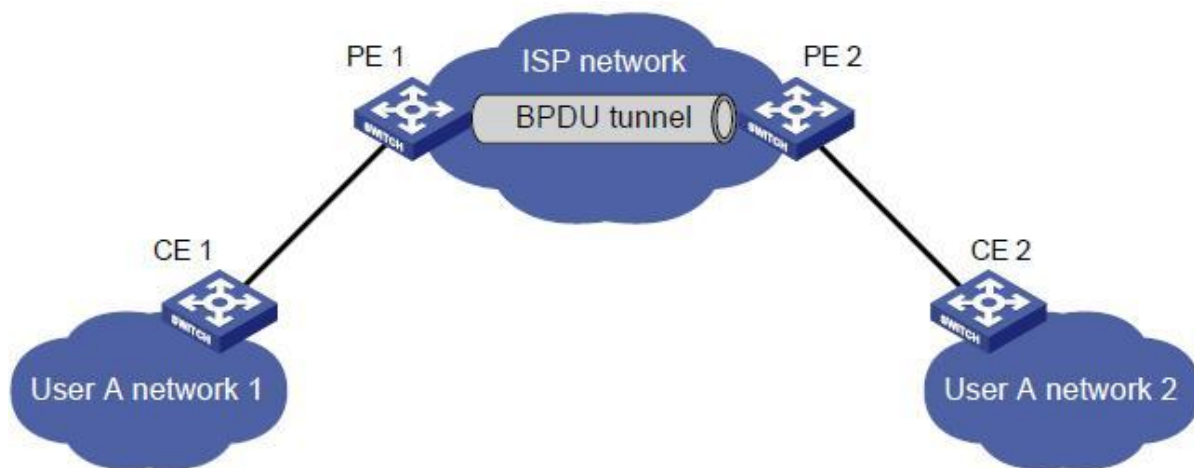

With L2TP, Layer 2 protocol packets from customer networks can be transparently transmitted in the service provider network:

1. After receiving a Layer 2 protocol packet from User A network 1, PE 1 in the service provider network encapsulates the packet, replaces its destination MAC address with a specific multicast MAC address, and then forwards the packet in the service provider network.

2. The encapsulated Layer 2 protocol packet (called bridge protocol data unit, BPDU for short) is forwarded to PE 2 at the other end of the service provider network, which de-encapsulates the packet, restores the original destination MAC address of the packet, and then sends the packet to User A network 2.

50.2 Configure BPDU-Tunnel

50.2.1 BPDU-tunnel Configuration List

Configuration Task	Description	Detailed Configuration
Configure BPDU-Tunnel Packet	Required	50.2.2
Configure BPDU-TunnelDestination MAC	Optional	50.2.3
Displays and Maintain BPDU-Tunnelconfiguration	Optional	50.2.4

50.2.2 Configure BPDU-Tunnel Packet

Operation	Command	Remarks
Enter global configuration mode	system-view	
Enter interface configuration mode	interface ethernet <i>interface-num</i>	
Configure the L2-tunnel packet	bpdu-tunnel [cdp lacp pagp stp udld vtp]	

50.2.3 Configure BPDU-Tunnel Destination MAC

By default, L2TP destination mac is 01:00:0c:cd:cd:d0

Operation	Command	Remarks
Enter global configuration mode	system-view	

Configure the rate for up to cpu	bpdu-tunnel dmac <i>mac-address</i>	
----------------------------------	--	--

50.2.4 Displays and Maintain BPDU-Tunnel Configuration

After finishing above configuration, user can check the configurations by command below.

Operation	Command	Remarks
Display L2TP configuration	display bpdu-tunnel interface [ethernet <i>interface-num</i>]	

Chapter 51 Local-Switch

51.1 Local-Switch Overview

Normally, packets coming from port A are not forwarded from port A by the GPON. However, it may require packets coming from the A port are forwarded from the A port sometimes. In this case, you can use the local-Switch.

51.2 Configure Local-Switch

51.2.1 Local-switch Configuration List

Configuration Task	Description	Detailed Configuration
Enable local-switch	Required	51.2.2
Displays and Maintain local-switch Configurations	Optional	51.2.3

51.2.2 Enable local-switch

Operation	Command	Remarks
Enter global configuration mode	system-view	
Enter interface configuration mode	interface ethernet <i>interface-num</i>	
Enable local-switch	local-switch	
Disable local-switch	undo local-switch	Disabled by default.

51.2.3 Displays and Maintain Local-switch Configurations

Operation	Command	Remarks
Displays the local-switch control	display local-switch interface [ethernet <i>interface-num</i>]	

Chapter 52 Port&CPU Utilization Alarm

52.1 Port&CPU Utilization Alarm Overview

The device utilization alarm is used to monitor port bandwidth, CPU occupation and alarm when congestion in order to administrator aware the running status between the network and device.

Exceed: when port bandwidth utilization over “exceed”, it triggers congestion alarm.

Normal: when port bandwidth utilization less “exceed”, it triggers recover alarm CPU utilization alarm also can set two trigger values, details as below:

Busy: when CPU utilization over “busy”, it triggers alarm of CPU busyness

Unbusy: when CPU utilization less “busy”, it triggers alarm of CPU idle Notes, all alarms will show in the list of Syslog..

52.2 Configure Port&CPU Utilization Alarm

52.2.1 Port & CPU Utilization Alarm Configuration List

Configuration Task	Description	Detailed Configuration
Configure Port Utilization Alarm	Required	52.2.2

Configure CPU Utilization Alarm	Required	52.2.3
Display and Debugging Device Utilization Alarm	Optional	52.2.4

52.2.2 Configure Port Utilization Alarm

Using below commands to configure port utilization. Enable port utilization in system and port mode by default. The “exceed” value equals 850M, the “normal” value equals 600M.

Operation	Command	Remarks
Enter global configuration mode	system-view	
Enable(disable)port utilization alarm with system mode	[undo] alarm all-packets	
Enter port configuration	interface ethernet <i>interface-num</i>	
Enable(disable)port utilization alarm with port mode	[undo] alarm all-packets	
Configure alarm value	alarm all-packets threshold { exceed <i>threshold</i> normal <i>threshold</i> }	

52.2.3 Configure CPU Utilization Alarm

Using below commands to configure CPU utilization. Enable CPU utilization by default. The “busy” value equals 90%, the “unbusy” value equals 60%.

Operation	Command	Remarks
Enter global configuration mode	system-view	
Enable(disable) CPU utilization alarm	[undo] alarm cpu	

Configure congestion value	alarm cpu threshold { busy <i>threshold</i> unbusy <i>threshold</i> }	
----------------------------	--	--

52.2.4 Display and Debugging Device Utilization Alarm

After finishing above configuration, you can show configuration by below commands.

Operation	Command	Remarks
Display the enable status and alarm value of CPU utilization alarm	display alarm cpu	
Display port utilization in system mode	display alarm all-packets	
Display port utilization and value in port mode	display alarm all-packets interface [ethernet <i>interface-num</i>]	

Chapter 53 Configure ONT Discovery

53.1 ONT Discovery Overview

ONU discovery refers to a process in which a newly connected or offline ONU accesses the PON.

53.2 Configure ONT Discovery

53.2.1 Comfigure ONT Discovery

ONT auto discovery is used to configure the ONT discovery function of GPON(XGPON) ports. This feature is disabled by default. GPON ONU and XGPON ONU need to be configured separately and do not share ONU IDs, so the maximum number of ONUs supported by each PON port is 256

Operation	Command	Remarks
Enter system view	system-view	
Configure the GPON ONT discovery distance	ont-autofind distance min num max num interface gpon { all port_num }	
Configure the XGPON ONT discovery	ont-autofind distance xgpon-min num xgpon-max num interface gpon all	

distance		
Enable GPON ONT discovery	ont-autofind interface gpon all	
Enable XGPON ONT discovery	ont-autofind interface xgpon all	
Configure GPON ONT discovery interval	ont-autofind interval-time <i>time</i> interface gpon all	
Configure XGPON ONT discovery interval	ont-autofind interval-time <i>time</i> interface xgpon all	
Enable GPON ONT discovery aging time	ont-autofind list-age interface gpon all	
Enable XGPON ONT discovery aging time	ont-autofind list-age interface xgpon all	
Configure GPON ONT discovery aging time	ont-autofind list-age time <i>num</i> interface gpon all	
Configure XGPON ONT discovery aging time	ont-autofind list-age time <i>num</i> interface xgpon all	

53.2.2 Configure ONT Silent

When the ONT authentication fails, it will enter a silent state. During the silent period, the OLT does not process the SN reported by the ONT, and this function is disabled by default.

Operation	Command	Remarks
Enter system view	system-view	
Enable authentication failure GPON ONT silence	ont-silent auth-fail interface gpon { all <i>port_num</i> }	
Enable authentication failure XGPON ONT silence	ont-silent auth-fail interface xgpon { all <i>port_num</i> }	
Configure the GPON ONT silent time for authentication	ont-silent auth-fail time <i>num</i> interface gpon { all <i>port_num</i> }	

failure		
Configure the XGPON ONT silent time for authentication failure	ont-silent auth-fail time <i>num</i> interface <i>xgpon</i> { <i>all</i> <i>port_num</i> }	
Enable the offline GPON ONT silence function	ont-silent offline interface <i>gpon</i> { <i>all</i> <i>port_num</i> }	
Enable the offline XGPON ONT silence function	ont-silent offline interface <i>xgpon</i> { <i>all</i> <i>port_num</i> }	
Configure the offline GPON ONT silent time	ont-silent offline time <i>num</i> interface <i>gpon</i> { <i>all</i> <i>port_num</i> }	
Configure the offline XGPON ONT silent time	ont-silent offline time <i>num</i> interface <i>xgpon</i> { <i>all</i> <i>port_num</i> }	

Chapter 54 Configure ONT Profile

54.1 ONT Profile Overview

ONT profile configuration can be used to uniformly configure ONTs. It is divided into eight profiles: alarm profile, DBA profile, downstream profile, line profile, multicast profile, rule profile, upstream profile, and specific profile.

54.2 Configure Alarm Profile

The Alarm profile is used to configure the alarm threshold for ONT transmission and reception. After binding the alarm profile to the ONT line profile, a corresponding alarm will be generated when the ONT transmission and reception light exceeds the range.

Operation	Command	Remarks
Enter system view	system-view	
Enter alarm profile view	alarm-profile { <i>index</i> [<i>name name</i>] <i>name name</i> }	
Configure TX power alarm	opm tx-threshold high <i>tx_power</i> low <i>tx_power</i>	
Configure RX power alarm	opm rx-threshold high <i>tx_power</i> low <i>tx_power</i>	
Delete optical power alarm	undo opm { tx-threshold rx-threshold }	

Save alarm profile	commit	
Display alarm profile	display alarm-profile { <i>index</i> name name }	
Display alarm profile bind info	display alarm-profile bound-info { all <i>index</i> }	

54.3 Configure DBA Profile

The DBA profile is used to configure the upstream dynamic bandwidth. According to the GPON standard, they are TYPE1 (fixed bandwidth), TYPE2 (assured bandwidth), TYPE3 (assured bandwidth + maximum bandwidth), TYPE4 (maximum bandwidth), and TYPE5 (mixed bandwidth).

Operation	Command	Remarks
Enter system view	system-view	
Enter DBA profile view	dba-profile { <i>index</i> [name name] name name }	
Configure GPON type 1	type 1 fix <i>fixed_bw</i> [method sr]	
Configure XGPON type 1	type 1 xgpon fix <i>fixed_bw</i> [method sr]	
Configure XGSPON type 1	type 1 xgspon fix <i>fixed_bw</i> [method sr]	
Configure GPON type 2	type 2 assured <i>assured_bw</i> [method sr]	
Configure XGPON type 2	type 2 xgpon assured <i>assured_bw</i> [method sr]	
Configure XGSPON type 2	type 2 xgspon assured <i>assured_bw</i> [method sr]	
Configure GPON type 3	type 3 assured <i>assured_bw</i> max <i>max_bw</i> [method sr]	
Configure XGPON type 3	type 3 xgpon assured <i>assured_bw</i> max <i>max_bw</i> [method sr]	

Configure XGSPON type 3	type 3 xgspn assured <i>assured_bw</i> max <i>max_bw</i> [method sr]	
Configure GPON type 4	type 4 max <i>max_bw</i> [method sr]	
Configure XGPON type 4	type 4 max <i>max_bw</i> [method sr]	
Configure XGSPON type 4	type 4 xgpon max <i>max_bw</i> [method sr]	
Configure GPON type 5	type 5 fix <i>fixed_bw</i> assured <i>assured_bw</i> max <i>max_bw</i> [method sr]	
Configure XGPON type 5	type 5 xgpon fix <i>fixed_bw</i> assured <i>assured_bw</i> max <i>max_bw</i> [method sr]	
Configure XGSPON type 5	type 5 xgspn fix <i>fixed_bw</i> assured <i>assured_bw</i> max <i>max_bw</i> [method sr]	
Save DBA configuration	commit	
Display DBA profile	display dba-profile { <i>index</i> name <i>name</i> }	
Display DBA profile bind info	display dba-profile bound-info { all <i>index</i> }	

54.4 Configure Downstream Profile

The Downstream profile is used to configure the ONT downstream rate limit. When referencing this template, you need to set qos-mode to gem-car mode in the line template.

Operation	Command	Remarks
Enter system view	system-view	
Create\Enter Downstream profile	downstream-profile { <i>index</i> [name <i>name</i>] name <i>name</i> }	
Configure the downstream bandwidth	downstream car <i>cir</i> <i>cbs</i> <i>cbs</i> pir <i>pir</i> pbs <i>pbs</i>	
Display downstream profile	display downstream-profile { <i>index</i> name <i>name</i> }	

Display downstream bind information	display downstream-profile bound-info { all <i>index</i> }	
-------------------------------------	--	--

54.5 Configure Line Profile

Line profile is used to configure related parameters such as ONT service flow mapping mode and service flow processing strategy.

Operation	Command	Remarks
Enter system view	system-view	
Creatl\Enter line profile	line-profile { <i>index</i> [name <i>name</i>] name <i>name</i> }	
Configure ONT model	model { f0-h210 f0-s210 f0-m210 }	Required
Configure tcont	tcont <i>num</i> dba-profile { <i>num</i> name <i>name</i> }	Required
Configure gempport	gem <i>num</i> tcont <i>num</i> [encrypt priority-queue <i>queue</i> downstream-profile <i>index</i> upstream-profile <i>index</i> vlan-profile <i>index</i>]	Required
Configure stream mapping mode	mapping mode { port port-priority port-vlan port-vlan-priority priority vlan vlan-priority }	Default VLAN mapping
Configure flow mapping	mapping <i>index</i> { vlan <i>vlan</i> priority <i>pri</i> port { eth <i>eth</i> veip iphost } } gem <i>index</i>	Required
Configure flow processing policies	port <i>vlan</i> <i>num</i> { eth <i>num</i> iphost ont } { default vlan <i>num</i> [<i>pri</i>] transparent vlan <i>num</i> { trunk q-in-q translate } [vlan <i>num</i> [<i>pri</i>]] }	
Configure multicast downstream policies	multicast downstream { tag <i>num</i> [port <i>num</i> <i>pri</i>] untag [port <i>num</i>] translate <i>vlan</i> [port <i>num</i> <i>pri</i>] }	
Disable the ONT multicast fast leave	multicast fast-leave disable [port <i>num</i>]	

Configure multicast group limit	multicast group-limit <i>num</i> [port num]	
Configure ONT multicast mode	multicast mode { igmp-snooping olt-control } [port num]	
Configure multicast upstream	multicast upstream { tag num [port num <i>pri</i>] translate vlan [port num <i>pri</i>] }	
Enable ONT FEC/ring check	ont { fec ring check }	
Disable port isolation	ont port-switch	
Configure ONT flow control	ont flow-control [port num]	
Configure the maximum number of MAC learning on the ONT.	ont mac-address-table max-mac-count <i>num</i> [port num]	
Shutdown ONT CATV port	ont shutdown <i>ont_id</i> catv-port num	
Configure Qos mode	qos-mode { gem-car priority-queue }	
Configure ONT port rate limit	port num egress cir <i>cir</i> pir <i>pir</i> cbs <i>cbs</i> pbs <i>pbs</i>	
Bind alarm/multicast profile	bind { alarm-profile multicast-profile } { <i>index</i> <i>name</i> }	
Save configuration	commit	
Display line profile	display line-profile { <i>index</i> name name }	
Display line profile bind information	display line-profile bound-info { all <i>index</i> }	

54.6 Configure Multicast Profile

The Multicast profile is used to configure parameters corresponding to controllable multicast. The multicast group access control permission currently supports two modes: preview and permit.

Operation	Command	Remarks
Enter system view	system-view	
Create\enter multicast profile	multicast-profile { <i>index</i> [name <i>name</i>] name <i>name</i> }	
Configure multicast control permit mode	multicast control index <i>index</i> permit mcast-ip <i>ip</i> [<i>end_ip</i> bandwidth <i>bandwidth</i> port <i>port</i> source-ip <i>ip</i> vlan <i>vlan</i>]	
Configure multicast control preview mode	multicast control index <i>index</i> preview mcast-ip <i>ip</i> [<i>end_ip</i> bandwidth <i>bandwidth</i> port <i>port</i> source-ip <i>ip</i> vlan <i>vlan</i>]	
Configure multicast control parameters	multicast control index <i>index</i> preview mcast-ip <i>ip</i> [permit-times <i>num</i> reset-time <i>num</i> time-interval <i>num</i> time-once <i>num</i>]	
Save configuration	commit	
Display multicast profile	display multicast-profile { <i>index</i> name <i>name</i> }	
Display multicast profile bind information	display multicast-profile bound-info { all <i>index</i> }	

54.7 Configure Rule Profile

The rule profile is used to configure ONTs to register, allowing ONTs that match the rules to register and deliver the corresponding line profile configuration. Once-on discovery mode means that after the template configuration is completed, the ONT must register within the specified time, and the ONT is not allowed to authenticate after the timeout.

The activation process of the ONU is controlled by the OLT, and the activation process is roughly as follows:

1. The ONU receives the working parameters through the Upstream_Overhead message;

2. The ONU adjusts its own parameters (such as transmit optical power) according to the received working parameters;
3. The OLT finds the serial number of the new ONU through the Serial_Number Acquisition process;
4. The OLT assigns ONU-IDs to all new ONUs;
5. The OLT measures the equalization delay of the new ONU;
6. The OLT transmits the measured equalization delay to the ONU;
7. The ONU adjusts the sending starting point of its upstream frame according to the equalization delay;

The above activation process is accomplished by exchanging uplink and downlink flags and PLOAM messages.

Operation	Command	Remarks
Enter system view	system-view	
Create/enter rule profile	rule-profile { gpon xgpon } { index [name name] name name }	
Configure LOID authentication	loid-auth loid [checkcode-auth code] line-profile index [once-on { aging-time time no-aging }] [ont-type { 10g/2.5g 10g/10g auto }]	
Configure password authentication	password-auth { string string hex hex } line-profile index [once-on [aging-time time no-aging]] [ont-type { 10g/2.5g 10g/10g auto }]	
Configure SN authentication	sn-auth { string-hex sn hex hex } [password-auth { string string hex hex }] line-profile index [ont-type { 10g/2.5g 10g/10g auto }]	

Save configuration	commit	
Display rule profile	display rule-profile { gpon xgpon } { <i>index</i> <i>name name</i> }	
Display the number of rule profile.	display rule-profile count interface { gpon xgpon } { <i>port_list</i> all }	
Display rule profile information of the registered ONT.	display rule-profile registered { sn { string-hex <i>sn</i> hex <i>hex</i> } loid <i>loid</i> interface { gpon xgpon } { all <i>pon_id</i> } }	
Display rule profile information of the unregistered ONT.	display rule-profile unregistered { sn { string-hex <i>sn</i> hex <i>hex</i> } loid <i>loid</i> interface { gpon xgpon } { all <i>pon_id</i> } }	
Display ONT rule profile information	display rule-profile register-info { sn { string-hex <i>sn</i> hex <i>hex</i> } loid <i>loid</i> interface { gpon xgpon } { all <i>pon_id</i> } }	

54.8 Configure Specific Profile

The specific profile is used to configure ONT-specific configuration. When the specific template conflicts with the configuration in the line profile, the configuration of the specific template takes effect.

Operation	Command	Remarks
Enter system view	system-view	
Create\enter specific profile	specific-profile { <i>index</i> [<i>name name</i>] <i>name name</i> }	
Bind alarm profile or multicast profile	bind { alarm-profile multicast-profile } { <i>index</i> [<i>name name</i>] <i>name name</i> }	
Configure ONT description	description <i>description</i>	
Configure gempport	gem <i>num</i> tcont <i>num</i> [encrypt priority-queue <i>queue</i> downstream-profile <i>index</i>	

	upstream-profile <i>index</i> vlan-profile <i>index</i>]	
Configure dynamic IP	ip-config mode dhcp vlan <i>vlan</i> [<i>pri</i>] host <i>host</i>	
Configure static IP	ip-config mode static ip-address <i>ip</i> mask <i>mask</i> gateway <i>gateway</i> primary-dns <i>dns1</i> secondary-dns <i>dns2</i> vlan <i>vlan</i> [<i>pri</i>]	
Configure port speed	ont neg-mode speed { 10 100 1000 auto } duplex { half full auto } [port <i>num</i>]	
Configure ONT ranging balance	ont ranging-balance { increase decrease } <i>num</i>	
Shutdown ONT CATV port	ont shutdown { ont_id <i>catv-port</i> <i>num</i> catv-port <i>num</i> port <i>num</i> }	
Configure CATV mode	ont catv-agc mode { rf-based optical-based } { increase decrease } <i>num</i> catv-port <i>num</i>	
Configure PoE max power	poe max-power <i>power</i> port <i>num</i>	
Configure PoE priority	poe priority { critical high low } port <i>num</i>	
Shutdown PoE	poe shutdown port <i>num</i>	
Configure SIP proxy-server	sip agent proxy-server ip [outbound-proxy <i>ip</i> registrar-server <i>ip</i> signal-port <i>port</i>]	
Configure SIP digitmap	sip digitmap dial-plan-id <i>id</i> dial-plan-token <i>digitmap</i>	
Configure SIP dynamic IP	sip user mode dhcp vlan <i>vlan</i> [<i>pri</i>] host <i>host</i>	
Configure SIP static IP	sip user mode static ip-address <i>ip</i> mask <i>mask</i> gateway <i>gateway</i> primary-dns <i>dns1</i> secondary-dns <i>dns2</i> vlan <i>vlan</i> [<i>pri</i>]	
Configure SIP account	sip user <i>user</i> description <i>description</i> name	

and password	<i>name password password telno num</i>	
Configure tcont	tcont <i>num dba-profile { num name name }</i>	
Save configuration	commit	
Display specific profile	display specific-profile { <i>index name name</i> }	
Display specific profile bind information	display specific-profile bound-info { all <i>index</i> }	

54.9 Configure Upstream Profile

The Upstream profile is used to configure the upstream rate limit of the ONT. When referencing this template, you need to set qos-mode to gem-car mode in the line profile.

Operation	Command	Remarks
Enter system view	system-view	
Create\enter upstream profile	upstream-profile { <i>index [name name] name name</i> }	
Configure ONT upstream	upstream car cir cir cbs cbs pir pir pbs pbs	
Save configuration	commit	
Display upstream profile	display upstream-profile { <i>index name name</i> }	
display upstream profile bind information	display upstream-profile bound-info { all <i>index</i> }	

54.10 Configure VLAN Profile

VLAN profile are used to configure service vlan translation rules. The VLAN profile needs to be referenced in the line profile or specific profile.

Operation	Command	Remarks
Enter system view	system-view	
Enter\creat vlan profile	vlan-profile { <i>index</i> [<i>name name</i>] <i>name name</i> }	
Configure vlan add rules	add inner-vlan <i>vlan</i> { <i>pri</i> } outer-vlan <i>vlan</i> { <i>pri</i> }	
Configure default vlan rules	default vlan <i>vlan</i> { <i>pri</i> }	
Configure vlan translate rules	translate cvlan <i>vlan</i> { <i>pri</i> } svlan <i>vlan</i> { <i>pri</i> }	
Configure vlan translate and add rules	translate-and-add cvlan <i>vlan</i> svlan <i>vlan</i> outer-vlan <i>vlan</i>	
Save configuration	commit	
Display VLAN profile	display vlan-profile { <i>index</i> <i>name name</i> }	
Display VLAN profile bind information	display vlan-profile bound-info { <i>all</i> <i>index</i> }	

Chapter 55 ONT System Management

55.1 ONT System Management Overview

ONT system management provides ONT management operations, including common functions such as ONT restart, upgrade, and automatic configuration.

55.2 Configure ONT System Management

55.2.1 ONT Reboot

ONT reboot is used for the OLT to remotely reboot the ONT.

Operation	Command	Remarks
Enter system view	system-view	
Reboot ONT	ont reboot { gpon xgpon } ont_list	

55.2.2 ONT Upgrade

ONT upgrade is used to upgrade the ONT software version. There are two modes for upgrading the ONT version: immediate and next-startup. Immediate means that after the software version is loaded into the ONT, the ONT will automatically restart and the software version will take effect immediately. Next-startup indicates that after the software version is

loaded into the ONT, the ONT will not restart automatically. You need to manually restart the software version to take effect.

Operation	Command	Remarks
Enter system view	system-view	
Configuring ONT upgrade	ont upgrade activemode-immediate { { gpon xgpon } <i>ont_id</i> sn { string-hex <i>sn</i> hex <i>hex</i> } }	Effective immediately
Configuring ONT Upgrade Filter	ont upgrade activemode-immediate { include exclude } { equipment-id <i>id</i> software-version <i>version</i> }	
Configuring the ONT upgrade time	ont upgrade activemode-immediate timer { <i>xx:xx:xx</i> <i>xxxx/xx/xx</i> interval <i>num</i> } { { gpon xgpon } <i>ont_id</i> sn { string-hex <i>sn</i> hex <i>hex</i> } }	Take effect after next reboot
Configuring the ONT upgrade	ont upgrade activemode-next-stratup { include exclude } { equipment-id <i>id</i> software-version <i>version</i> }	
Configuring the ONT upgrade time	ont upgrade activemode-next-startup timer { <i>xx:xx:xx</i> <i>xxxx/xx/xx</i> interval <i>num</i> } { { gpon xgpon } <i>ont_id</i> sn { string-hex <i>sn</i> hex <i>hex</i> } }	
Display ONT upgrade progress	display ont upgrade-progress { image ont-configuration } { { gpon xgpon } <i>ont_id</i> all }	

55.2.3 ONT Activation

ONT activation is used to activate the ONT. All ONT IDs are active by default. After the online ONT is deactivated, the ONT will be forced to go offline. If the discovery function of the PON port is enabled, you can view the deactivated ONT in the discovery list.

Operation	Command	Remarks
Enter system view	system-view	
Active ONT	ont active { gpon xgpon } ont_id	
Deactive ONT	ont deactivate { gpon xgpon } ont_id	

55.2.4 ONT Auto-configuration

When ONTs of the same type register in batches, ONT automatic configuration can be performed. You need to enable the ONT auto-configuration function first, and then configure the auto-configuration parameters. Different types of ONTs can deliver different line template configurations based on the Equipment ID.

Operation	Command	Remarks
Enter system view	system-view	
Enable ONT auto-configuration	ont auto-config	
Configure ONT auto-configuration parameters	ont auto-config { name name num } { all-ont all-sfu all-hgu equipment-id id } line-profile { index auto } [ont-type { 10g/2.5g 10g/10g auto }]	

55.2.5 ONT Configuration Reset

This function is used to reset ONT WAN configuration and WIFI configuration. It is a private protocol and needs ONT support.

Operation	Command	Remarks
Enter system view	system-view	
Reset ONT configuration	ont reset { all wan wifi } { gpon xgpon } ont_id	

55.3 ONT Log Management

ONT log management is used to configure the ONT logging function. Configurable ONT log prefix and timestamp.

Operation	Command	Remarks
Enter system view	system-view	
Configure the ONT log server IP	ont-logging ip	
Enable ONT logging	ont-logging buffer { gpon xgpon } { all ont_id }	
Enable ONT log printing	ont-logging monitor { num all } { gpon xgpon } { all ont_id }	
Configure ONT log prefix	ont-logging prefix { sn [ont_id] ont_id [sn] }	
Configure ONT log timestamp	ont-logging timestamps { datetime notime rfc5424 uptime }	
Display ONT log records	display ont-logging buffer { all { gpon xgpon } ont_id }	
Display ONT log function	display ont-logging	

Chapter 56 Display ONT Information

56.1 Display ONT Information

Viewing ONT information includes viewing optical power, port statistics, status, and version information.

56.1.1 Display ONT Optical Power

Operation	Command	Remarks
Enter system view	system-view	
Display single ONT optical power	display ont optical-info { gpon xgpon } <i>ont_id</i>	
Display multi ONT optical power	display ont optical-info interface { gpon xgpon } { all <i>pon_list</i> }	

56.1.2 Display ONT Traffic Statistics

Operation	Command	Remarks
Enter system view	system-view	
Display ONT traffic statistics	display ont statistics performance { gpon xgpon } <i>ont_id</i> [port num]	
Display ONT traffic statistics	display ont statistics { gpon xgpon } <i>ont_id</i> [gem { broadcast multicast unicast } port num traffic]	

56.1.3 Display ONT Port Status

Operation	Command	Remarks
Enter system view	system-view	
Display the voice port status	display ont port-status { gpon xgpon } <i>ont_id pots-port num</i>	
Display the CATV port status	display ont port-status { gpon xgpon } <i>ont_id catv-port num</i>	
Display Ethernet port status	display ont port-status { gpon xgpon } <i>ont_id port num</i>	

56.1.4 Display ONT Multicast

Operation	Command	Remarks
Enter system view	system-view	
Display ONT multicast	display ont multicast { gpon xgpon } <i>ont_id [port num]</i>	

56.1.5 Display ONT details

Operation	Command	Remarks
Enter system view	system-view	
Display all ONT information	display ont info { { gpon xgpon } ont_id interface gpon { all pon_list } sn { string-hex sn hex hex } }	
Display online\offline ONT information	display ont info { online offline } { { gpon xgpon } ont_id interface gpon { all pon_list } sn { string-hex sn hex hex } }	
Display the number of ONTs in the PON port	display ont info count interface { gpon xgpon } { all pon_list }	
Display the ONT information of the active and standby PON ports	display ont info { active standby } { { gpon xgpon } ont_id interface { gpon xgpon } { all pon_list } sn { string-hex sn hex hex } }	

56.1.6 Display ONT Profile

Operation	Command	Remarks
Enter system view	system-view	
Display single ONT profile information	display ont profile { gpon xgpon } ont_id	
Display ONT profile information of PON port	display ont profile interface { gpon xgpon } { all pon_list }	

56.1.7 Display ONT Description

Operation	Command	Remarks
Enter system view	system-view	
Display ONT description	display ont description { { gpon xgpon } onu_list interface { gpon xgpon } { all pon_list } }	

56.1.8 Display ONT Upgrade Status

Operation	Command	Remarks
Enter system view	system-view	
Display ONT upgrade status	display ont upgrade-progress { image ont-configuration } { { gpon xgpon } onu_list all }	

56.1.9 Display ONT Version

Operation	Command	Remarks
Enter system view	system-view	
Display ONT version	display ont version interface { gpon xgpon } { pon_list all }	

56.1.10 Display ONT MAC

Operation	Command	Remarks
Enter system view	system-view	
Display ONT MAC address	display ont mac-address-table { <i>mac</i> { gpon xgpon } <i>ont_id</i> interface { gpon xgpon } { all <i>pon_id</i> }	

56.1.11 Display ONT Capability

Operation	Command	Remarks
Enter system view	system-view	
Display ONT capability	display ont capability { gpon xgpon } <i>ont_id</i>	

56.1.12 Display ONT PoE Feature

Operation	Command	Remarks
Enter system view	system-view	
Display PoE power	display ont poe power { gpon xgpon } <i>ont_id</i> port num	
Display PoE status	display ont poe status { gpon xgpon } <i>ont_id</i> port num	

56.1.13 Display Rogue ONT Detection

Operation	Command	Remarks
Enter system view	system-view	
Display rogue ONT detection	display ont anti-rogueont config interface { gpon xgpon } { <i>pon_list</i> all }	